



# Modicon X80 modules platform

The common platform of modules for  
Modicon M580 and M340 PLCs/PACs

# Quick access to product information

## Get technical information about your product

References

**Modicon TM3**  
I/O expansion modules for Modicon controllers  
Analog I/O modules

Number and type of channels	Input range	Output range	Resolution	Input terminal (Modicon)	Reference	Weight (kg)
2 enhancement inputs	-10...+10 VDC 0...20 mA, 4...20 mA	10 mA or 10 mA + sign	12 bits or 12 bits	Terminal 2 Terminal 3	TM3AI2H TM3AI2H	0,110 0,236
4 enhancement inputs	-10...+10 VDC 0...20 mA, 4...20 mA	10 mA or 10 mA + sign	12 bits or 12 bits	Terminal 18 Terminal 19	TM3AI4H TM3AI4H	0,110 0,236
4 enhancement or temperature inputs	-10...+10 VDC 0...20 mA, 4...20 mA Thermocouple (K, J, E, S, T, N, R, C, O) Resistance (Pt100, Ni100, Pt1000, Ni1000)	10 mA or 10 mA + sign	12 bits or 12 bits	Terminal 18 Terminal 19	TM3AI4T TM3AI4T	0,110 0,236
4 differential temperature inputs	-10...+10 VDC 0...20 mA, 4...20 mA Thermocouple (K, J, E, S, T, N, R, C, O) Resistance (Pt100, Ni100, Pt1000, Ni1000)	10 mA or 10 mA + sign	12 bits or 12 bits	Terminal 18 Terminal 19	TM3AI4D TM3AI4D	0,110 0,236
2 enhancement	-10...+10 VDC	10 mA or 10 mA + sign	12 bits or 12 bits	Terminal 2 Terminal 3	TM3AI2H TM3AI2H	0,110 0,236

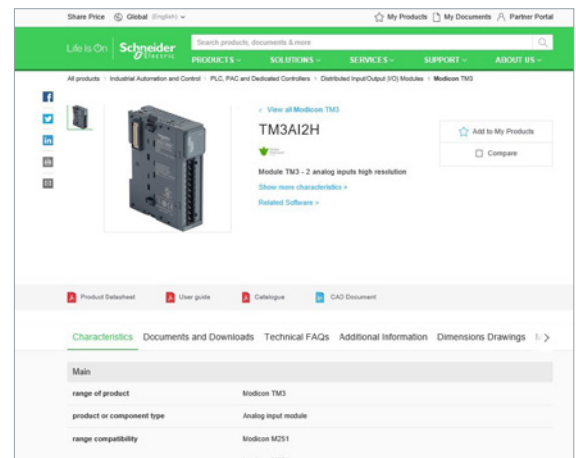

Each commercial reference presented in a catalog contains a hyperlink. Click on it to obtain the technical information of the product:

- Characteristics, Dimensions and drawings, Mounting and clearance, Connections and schemas, Performance curves
- Product image, Instruction sheet, User guide, Product certifications, End of life manual

## Find your catalog

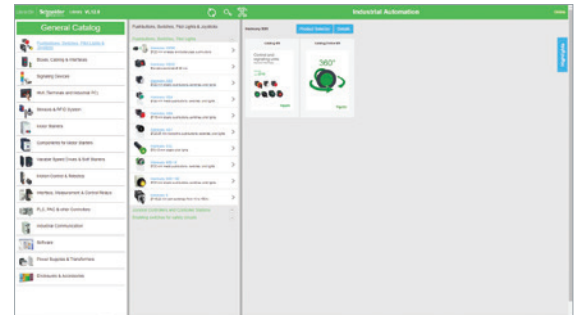

- > With just 3 clicks, you can reach the Industrial Automation and Control catalogs, in both English and French
- > Download Digi-Cat with this [link](#)

- Updated quarterly
- Embeds product selectors and configurators, 360° images, training centers,
- Optimized search by commercial reference

## Select your training



- > Find the right [Training](#) for your needs on our Global website
- > Locate the training center with the selector tool, using this [link](#)



# General contents

Presentation . . . . .	1
Racks and power modules . . . . .	2
I/O modules . . . . .	3
Safety I/O and power modules . . . . .	4
Communication and expert modules . . . . .	5
Ruggedized modules . . . . .	6
Compatibility with OsiSense XU/XS . . . . .	7
Standards and certifications . . . . .	8
Services, index. . . . .	9

In this catalog, all instances of words that refer to Safety without precision must be understood as referring to “Functional Safety” according to IEC 61508 and IEC 61511.

Schneider Electric's IoT-enabled, plug-and-play, open, secure, interoperable architecture and platform, in Industries, Infrastructures, Data Centers, and Buildings.

### Innovation at every level

EcoStruxure is based on a three-tiered technology stack delivering innovation at every level, from connected products to edge control and apps, analytics, and services.

Together with our hybrid segments approach, this enhances your value around safety, reliability, operational efficiency, sustainability, and connectivity across 6 domains of expertise:

- Power
- IT
- Building
- Machine
- Plant
- Grid

### Dedicated architectures and IoT

We tailor our solutions in the form of dedicated reference architectures for plants:

- Management systems
- Power systems
- Data center systems
- Industrial plant and machine systems
- Smart grid systems

The Industrial Internet of Things (IIoT) gives an additional boost to technologies. That's why we provide our customers with an IoT-enabled architecture and platform offering simple, reliable, productive, and cost-efficient solutions.

### Cybersecurity solutions

Robust cybersecurity protection is a must, and Schneider Electric's solutions can deliver it, regardless of business type or industry.

The vendor-agnostic services provided by our skilled professionals help to protect your entire critical infrastructure. We help to assess your risk, implement cyber-specific solutions, and maintain your onsite defenses over time, while integrating appropriate IT policies and requirements.

This is our difference and your advantage.

### Enhanced safety

With the release of M580 Safety, Schneider Electric further expands the EcoStruxure platform.

This consolidates our position as one of the most trusted industrial safety vendor, with thousands of Modicon and Triconex safety systems protecting the most critical industrial processes globally.

## EcoStruxure™ for Industry

Innovation At Every Level



(1) The Schneider Electric industrial software business and AVEVA have merged to trade as AVEVA Group plc, a UK listed company. The Schneider Electric and Life is On trademarks are owned by Schneider Electric and are being licensed to AVEVA by Schneider Electric.



---

- Overview ..... [page 1/2](#)
- Composition ..... [page 1/6](#)
- Architectures, software configuration ..... [page 1/7](#)
- Compatibility ..... [page 1/8](#)



1

## Modicon X80 I/O, a new remote I/O system



Common I/O platform for Modicon M340, M580, and Quantum Ethernet I/O



ATEX and IECEx zone 2/22



The Modicon X80 I/O platform serves as a common platform for Modicon M340, Modicon Quantum Ethernet I/O, Modicon M580 PACs, and future Modicon Mx80 controllers. This common platform means that a much smaller stock of spare parts needs to be held, and maintenance and training costs are significantly reduced. A common configuration tool is used for all PAC modules using EcoStruxure Control Expert (1) with a high level of services such as bit forcing and structured device DDT. This platform offers a wide choice of Schneider Electric I/O modules (discrete, analog, expert, and communication).

### Compact

- > The Modicon X80 I/O platform features the latest I/O technology, making it extremely compact.
- > It has smaller cabinet dimensions, with up to 64 discrete I/O for some modules.



Modicon X80 I/O platform

### Robust

- > Offering more than required by the standards
- > Certified for Hazardous Location Class I Division 2 Groups ABCD and for ATEX/IECEx zone 2/22 (depending on the model, see [pages 8/2 to 8/9](#))

Characteristics	Modicon X80 I/O platform	IEC standards Values required by
<b>Mechanical constraints</b>	<b>Levels reached</b>	<b>IEC 60068-2</b>
Shock	30 g	> 15 g
Vibrations	3 g	> 1 g
<b>Electrical immunity</b>	<b>Levels reached</b>	<b>IEC 61131-2</b>
Radiated field	15 V/m	> 10 V/m
Electrostatic discharges by contact	6 kV	> 4 kV
<b>Environmental immunity</b>	<b>Working values</b>	<b>IEC 61131-2</b>
Temperature	0...60 °C/32... 140 °F	> 5...55 °C/41... 131 °F
Modicon X80 ruggedized I/O offer	- 25...70 °C/32... 158 °F	> 5...55 °C/41... 131 °F
<b>Corrosive environments (coated versions)</b>		<b>Class Gx, 3C4, Kb, 3S4, 3B2</b>

### Sustainable

- > Common X80 I/O modules reduce training and maintenance costs
- > Hot swappable
- > Existing solutions for migrating from legacy I/O to the Modicon X80 I/O platform
- > Green Premium Eco Label

(1) EcoStruxure Control Expert software continues the Unity Pro range of software and corresponds to versions ≥ 14 of Unity Pro.

### M580 Safety



Clear distinction between safety and process



### Regulatory requirements

Good practices dictate that control systems must be designed to keep process control functions separate and operationally independent from safety functions. This is usually achieved using a controller for the process and a separate system for safety.

### Our solution to combine SAFE and PROCESS management in one application

- > Dual processing capability to control safety and process functions independently
- > Unifying independent plant safety and process control to help protect the entire operating environment
- > Minimized impact of standard process failure on plant safety, its people, and assets
- > No need to design, install, and maintain separate safety systems
- > Same tools, wiring methods, and I/O structures as Modicon M580 controller

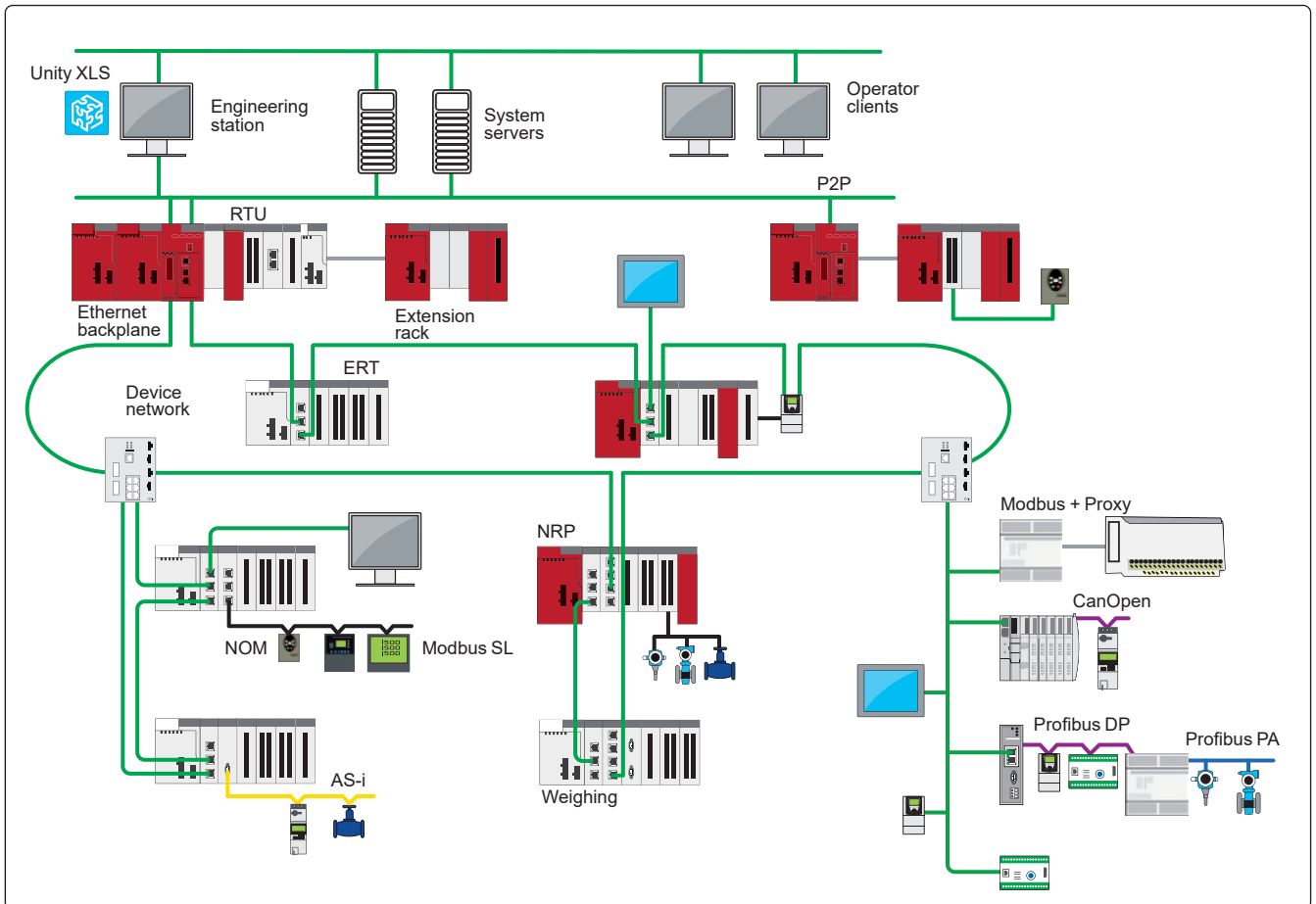

Typical common Safety architecture with Modicon M580 Safety

**+** Combining standard process and safety in a single M580 project





### Certifications and standards

Depending on the model, Modicon X80 modules comply with the following standards:

- > Merchant navy: IACS E10 and agencies: ABS, BV, DNV, GL, LR, RINA, RMRS, and CCS
  - > International certifications: CE, UL, CSA, RCM, EAC
  - > Power generation market: IEC 61000-6-5, IEC 61850-3
- See [pages 8/2 to 8/9](#) for more information.

#### Merchant navy



#### International certifications





### Market segments

> The EcoStruxure Control Expert (1) function block software libraries make the Modicon X80 I/O platform ideally suited for the following market segments:



Water & waste water



Mining, minerals & metals



Consumer Packaged Goods



Oil & gas

(1) Unity Pro software in earlier versions.



1



Modicon X80 I/O platform with Modicon M580 processor



Modicon X80 I/O platform with Modicon M340 processor



Modicon X80 EIO drop with CRA bus terminal module



Ethernet Modbus/TCP DIO drop with PRA module

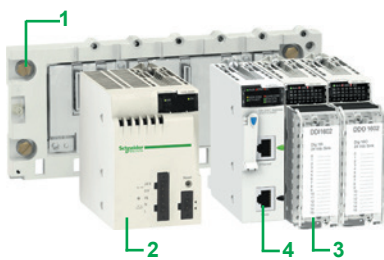

## Presentation

The Modicon X80 I/O platform serves as the common base for automation platforms by simply adding a dedicated processor (1).

It may also:

- form part of a Quantum and Modicon M580 Ethernet I/O architecture as an Ethernet RIO (EIO) drop with a CRA bus terminal module
- form an Ethernet Modbus/TCP DIO drop with a PRA module

The Modicon X80 I/O platform is available in single-rack or multi-rack configuration.

This platform may also accept automation platform-dedicated modules (communication, application-specific, etc.).

One Modicon X80 drop may support two racks separated by a cumulative distance of up to 30 m/98 ft.

This platform, common to several automation platforms, can reduce maintenance and training costs as it comprises:

- a single range of spare parts in stock
- training common to several PLCs

Based on the latest I/O technology, the Modicon X80 I/O platform offers:

- high-quality ruggedness and compactness
- compliance with international certifications (ATEX, IEC, etc.)
- a wide selection of modules: discrete or analog I/O, expert modules, communication modules, etc.

This platform is programmed and configured using EcoStruxure Control Expert (2) software.

Bit forcing simplifies simulation and structured data simplifies diagnostics.

## Description

### Modicon X80 I/O platform

The Modicon X80 I/O platform, which can be used in-rack and/or in remote I/O drops (RIO), Ethernet remote I/O drops (EIO), and/or distributed I/O drops (DIO) depending on the type of PLC (M580, M340, Quantum, etc.), comprises the following elements:

- 1 X-bus racks with 4, 6, 8, or 12 slots or Ethernet + X-bus racks with 4, 8, or 12 slots for single power supply, and Ethernet + X-bus racks with 6 or 10 slots for dual power supply
- 2 AC or DC power supply modules
- 3 Discrete and analog I/O modules
- 4 RTU (remote terminal unit) serial link, AS-Interface, and other communication modules

The additional modules offered include:

- Ethernet (Modbus/TCP, Ethernet/IP) and CANopen master communication and supplementary modules dedicated to several automation platforms such as Modicon M340 or Modicon M580
- Ethernet Global Data module specifically designed to provide the Global Data service for inter-controller communication
- Communication via fiber optic transceiver modules
- Application-specific modules: counter, motion control, SSI encoder, time-stamping, frequency input
- TPP (Technology Partner Program) partner modules: weighing, Wi-Fi

### Treatment for harsh environments

With “ruggedized” modules, the Modicon X80 I/O platform may be used in harsh environments or within a range of operating temperatures from -25 to +70 °C/-13 to +158 °F (see page 6/2).

(1) See the compatibility guide on page 1/8.

(2) EcoStruxure Control Expert software continues the Unity Pro range of software and corresponds to versions ≥ 14 of Unity Pro.

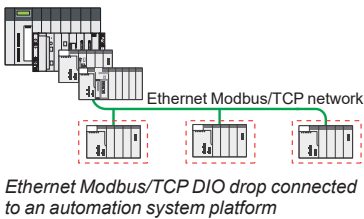
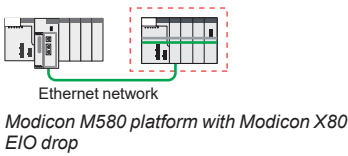
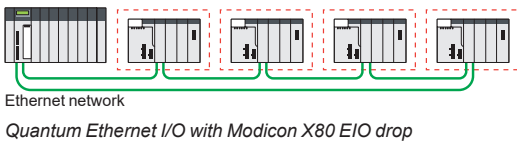

EcoStruxure Control Expert

### Architectures based on the Modicon X80 I/O platform

#### Single-rack or multi-rack local I/O configuration with Modicon M580 or M340 processor

This configuration comprises:

- a Modicon X80 I/O primary rack with a Modicon M580 or M340 processor
- a Modicon X80 I/O secondary rack

This configuration may comprise 4 racks with **BMXP342●●●** processors separated by a maximum cumulative distance of 30 m/98 ft. It can comprise up to 7 racks with M580 processors.

#### Quantum Ethernet I/O with Modicon X80 EIO drop

This architecture comprises:

- a Quantum Ethernet I/O platform comprising a processor and a CRP Ethernet head adapter
- one or more Modicon X80 EIO drops with a standard or performance CRA drop adapter

This configuration may include:

- 16 drops with **140CPU6●1●●** processors
- 31 drops with **140CPU6●2●●/140CPU6●8●●** processors

#### Modicon M580 with Modicon X80 EIO drop

This architecture comprises:

- a Modicon M580 automation platform comprising a processor and dedicated modules
- one or more Modicon X80 EIO drops with a standard or performance BMXCRA drop adapter on an X-bus rack or
- one or more Modicon X80 EIO drops with a BMECRA drop adapter on an Ethernet + X-bus rack

#### Ethernet Modbus/TCP DIO drop connected to an automation system platform

This architecture comprises:

- a Quantum/Premium/M580/M340 automation platform
- one or more Ethernet Modbus/TCP DIO drops with a **BMXPRA0100** peripheral remote I/O adapter, a power supply, and I/O

### Software configuration

EcoStruxure Control Expert (1) programming software is required to set up the Modicon X80 I/O platform.

The EcoStruxure Control Expert (1) function block software libraries make it possible to meet the needs of specialist applications in various fields of application such as:

- Water and Waste Water (WWW)
- Consumer Packaged Goods (CPG)
- Mining, Minerals, Metals (MMM)
- Oil & Gas (O&G)

(1) Unity Pro software in earlier versions.







---

## Single-rack configuration

- Presentation, description, references ..... [page 2/2](#)
- Accessories ..... [page 2/5](#)

## Multi-rack configuration

- Presentation, description ..... [page 2/6](#)
- References ..... [page 2/8](#)

## X80 power supply modules

- Presentation, description ..... [page 2/10](#)
- Functions, references ..... [page 2/11](#)





### Presentation

The Modicon X80 I/O platform is compatible with two types of backplanes: dual Ethernet and X-bus backplanes or X-bus backplanes (1). One Ethernet switch is embedded inside the backplane with connectivity to some slots on the backplane, and not all slots have Ethernet connectivity.

X-bus functionality is preserved and conforms to the legacy implementation and specification. The X-bus will be used in a subset of modules on the Ethernet backplane.

The backplanes provide the power supply for the modules in the rack.

**BMXXBP●●00** racks are basic elements in Modicon X80 I/O platform single-rack and multi-rack configurations. They assign a rack number to X-bus slots. They also perform the following functions:

- Mechanical function: They are used to install modules in a PLC station (power supply, processor, discrete, analog, and application-specific I/O). These racks can be mounted on a panel, plate, or DIN rail:
  - Inside enclosures
  - On machine frames, etc.
- Electrical function: The racks incorporate X-bus (proprietary bus). They are used to:
  - Distribute the power supplies required for each module in the same rack
  - Distribute data and service signals for the entire PLC station
  - Hot swap modules during operation

**BMEXBP●●00** racks provide the following services to X-bus slots:

- Supply a rack number
- Supply the interconnection for the slots in the main and extended backplanes

**BMEXBP●●02** are dual power supply racks with two CPS slots for two redundant power supplies. They:

- Are only compatible with redundant power supplies
- Ensure security of power supply in high-availability applications

The Ethernet interface is the main communication medium in the Ethernet backplane. The Ethernet modules on the Ethernet backplane are attached to one of several ports. The modules connect to the Ethernet switch chip embedded in the Ethernet backplane.

The Ethernet backplane provides the following services to ETH slots:

- ETH connection to ETH slots
- Point-to-point connection

### Description

#### X-bus backplanes

**BMXXBP●●00** racks are available in 4, 6, 8, or 12-slot versions and comprise:

- 1 A metal frame that performs the following functions:
  - Holds the X-bus electronic card and helps it withstand EMI and ESD type interference
  - Holds the modules
  - Gives the rack mechanical rigidity
- 2 A ground terminal for grounding the rack
- 3 4 holes (big enough for M6 screws) for mounting the rack on a frame
- 4 2 fixing points for the shielding connection bar
- 5 Tapped holes to take the locking screw on each module
- 6 A connector for a rack expansion module, marked **XBE**
- 7 40-way female ½ DIN connectors forming the electrical connection between the rack and each module, marked **CPS, 00...11** (the rack is delivered with each connector protected by a cover, which needs to be removed before inserting the module)
- 8 Slots for anchoring the module pins

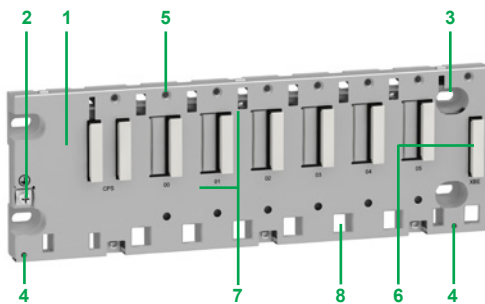

BMXXBP0600 rack with 6 slots

(1) Mandatory PV02 version or later.

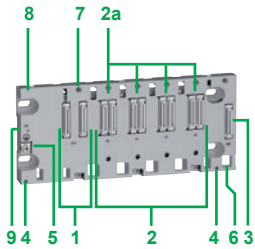

BMEXBP0400 backplane

### Description (continued)

#### Dual Ethernet and X-bus backplanes

The number of X-bus and Ethernet slots found on a backplane depends on the backplane size.

**BMEXBP0400/BMEXBP0800** are 4/8-slot dual Ethernet and X-bus backplanes with:

- 1 CPS slot for power supply
- 2 4 slots (**BMEXBP0400**)/8 slots (**BMEXBP0800**) with:
  - 2a 4/8 Ethernet and X-bus connectors for mixed modules
- 3 Extension: 1 connector for a X-bus backplane expansion
- 4 2 fixing points for the shielding connection bar
- 5 Protective ground screw
- 6 Slots for anchoring the module pin
- 7 Tapped holes for the locking screw on each module
- 8 4 holes for M4, M5, M6, or UNC #6-32 screws (4.32 mm to 6.35 mm/0.17 to 0.25 in.)
- 9 Rack fastened to 35 mm/1.38 in. wide and 15 mm/0.59 in. deep DIN rails. Mounting on a 35 mm/1.38 in. wide and 7.5 mm/0.295 in. deep DIN rail is also possible (in this case, the product withstands less mechanical stress).

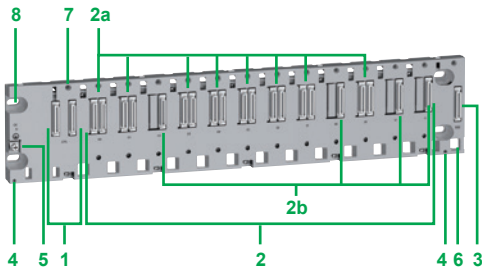

BMEXBP1200 backplane

**BMEXBP1200** is a 12-slot dual Ethernet and X-bus backplane with:

- 1 CPS slot for power supply
- 2 12 slots with:
  - 2a 8 Ethernet and X-bus connectors for mixed modules
  - 2b 4 X-bus connectors for X-bus modules
- 3 Extension: 1 connector for an X-bus backplane expansion
- 4 2 fixing points for the shielding connection bar
- 5 Protective ground screw
- 6 Slots for anchoring the module pin
- 7 Tapped holes for the locking screw on each module
- 8 4 holes for M4, M5, M6, or UNC #6-32 screws (4.32 mm to 6.35 mm/0.17 to 0.25 in.)

#### Dual power supply backplanes

**BMEXBP0602** is a 6-slot dual Ethernet and X-bus backplane with:

- 1 2 CPS slots for **BMXCPS4002** redundant power supply only
- 2 6 slots with:
  - 2a 6 Ethernet and X-bus connectors for mixed modules
- 3 Extension: 1 connector for an X-bus backplane expansion
- 4 2 fixing points for the shielding connection bar
- 5 Protective ground screw
- 6 Slots for anchoring the module pin
- 7 Tapped holes for the locking screw on each module
- 8 4 holes for M4, M5, M6, or UNC #6-32 screws (4.32 to 6.35 mm/0.17 to 0.25 in.)
- 9 Rack is fastened to 35 mm/1.38 in. wide and 15 mm/0.59 in. deep DIN rails. Mounting on a 35 mm/1.38 in. wide and 7.5 mm/0.295 in. deep DIN rail is also possible (in this case, the product withstands less mechanical stress).

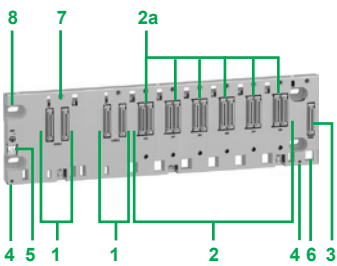

BMEXBP0602 backplane

**BMEXBP1002** is a 10-slot dual Ethernet and X-bus backplane with:

- 1 2 CPS slots for **BMXCPS4002** redundant power supply only
- 2 10 slots with:
  - 2a 8 Ethernet and X-bus connectors for mixed modules
  - 2b 2 X-bus connectors for X-bus modules
- 3 Extension: 1 connector for an X-bus backplane expansion
- 4 2 fixing points for the shielding connection bar
- 5 Protective ground screw
- 6 Slots for anchoring the module pin
- 7 Tapped holes for the locking screw on each module
- 8 4 holes for M4, M5, M6, or UNC #6-32 screws (4.32 to 6.35 mm/0.17 to 0.25 in.)

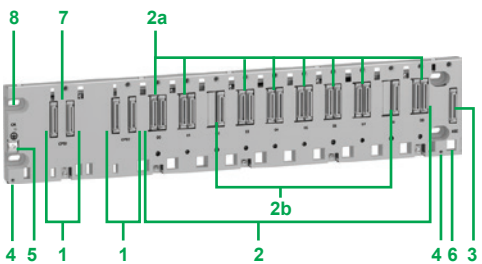

BMEXBP1002 backplane

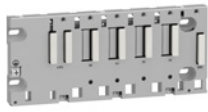

BMXXBP0400

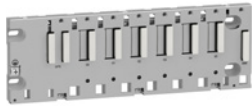

BMXXBP0600

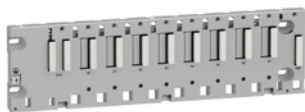

BMXXBP0800

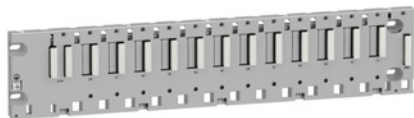

BMXXBP1200

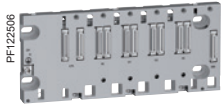

BMEXBP0400

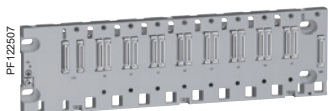

BMEXBP0800

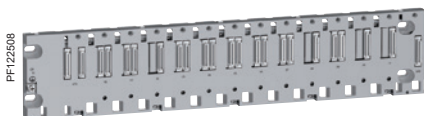

BMEXBP1200

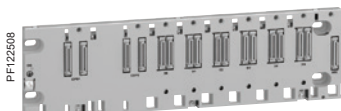

BMEXBP0602

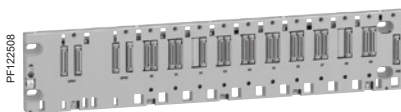

BMEXBP1002

### X-bus racks

Description	Type of module to be inserted	No. of slots (1)	Power consumption (2)	Reference	Weight kg/lb
X-bus racks	BMXCPS power supply, <b>BMXP34</b> or <b>BMEP58</b> processor, I/O modules, communication modules and application-specific modules (counter, motion control, and serial)	4	1 W	<b>BMXXBP0400</b>	0.630/ 1.389
		6	1.5 W	<b>BMXXBP0600</b>	0.790/ 1.742
		8	2 W	<b>BMXXBP0800</b>	0.950/ 2.094
		12	–	<b>BMXXBP1200</b>	1.270/ 2.780

### Ethernet + X-bus racks (3) (4)

Description (5)	Type of module to be inserted	Ethernet connectors	X-bus connectors	Power consumption (6)	Reference (3)	Weight kg/lb
4-slot Ethernet + X-bus backplane	BMXCPS power supply, <b>BMEP58/BMEH58</b> processor, I/O modules, communication modules and application-specific modules (counter, motion control, and serial)	4	4	2.8 W	<b>BMEXBP0400</b>	0.719/ 1.500
8-slot Ethernet + X-bus backplane		8	8	3.9 W	<b>BMEXBP0800</b>	1.064/ 2.350
12-slot (8 Ethernet + X-bus/4 X-bus) backplane		8	12	3.9 W	<b>BMEXBP1200</b>	1.398/ 3.080
6-slot Ethernet + X-bus dual power supply backplane	BMXCPS4002 redundant power supply, <b>BMEP58/BMEH58</b> processor, I/O modules, communication modules and application-specific modules (counter, motion control, and serial)	6	6	3.9 W	<b>BMEXBP0602</b>	1.377/ 3.036
10-slot (8 Ethernet + X-bus/2 X-bus) dual power supply backplane		8	10	3.9 W	<b>BMEXBP1002</b>	1.377/ 3.036

(1) Number of slots taking the processor module, I/O modules, communication modules, and application-specific modules (excluding power supply module).  
 (2) Power consumption of anti-condensation resistor(s).  
 (3) In an M580 architecture, Ethernet backplanes can be used for RIO drop Ethernet (EIO) but not as expansion racks anywhere. For expansion racks, it is necessary to use BMXXBP0400/0600/0800/1200 racks.  
 (4) For multi-rack configuration, see page 2/6.  
 (5) Number of slots for maximum number of modules excluding power supply rack expansion modules.  
 (6) Power consumption of anti-condensation resistor(s).

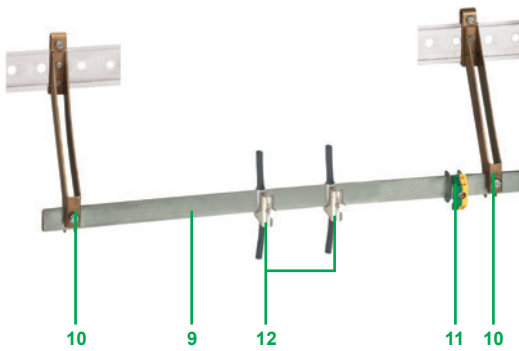

BMXXSP cable shielding connection kit

### Description

#### Dual Ethernet and X-bus backplanes

#### To be ordered separately:

A **BMXXSP** cable shielding connection kit, used to help protect against electrostatic discharge when connecting the shielding on cordsets for connecting:

- Analog, counter, and motion control modules
- A Magelis XBT operator interface to the processor (via **BMXXCAUSBH** shielded USB cable)

The **BMXXSP** shielding system comprises:

- 9 A metal bar that takes the clamping rings and the grounding terminal
- 10 Two sub-bases to be mounted on the rack
- 11 A grounding terminal (not included)
- 12 Not included in the shielding connection kit, the **STBXSP30** clamping rings (sold in lots of 10, cross-section 1.5...6 mm<sup>2</sup>/16...10 AWG or 5...11 mm<sup>2</sup>/10...7 AWG)



STBXSP3000 + STBXSP30

### Accessories

Description	For use with	Reference	Weight kg/lb
<b>Shielding connection kits</b> comprising: - 1 metal bar - 2 support sub-bases	BMXBP0400 rack	<a href="#">BMXXSP0400</a>	0.280/ 0.617
	BMXXBP0600 rack	<a href="#">BMXXSP0600</a>	0.310/ 0.683
	BMEXBP0602 rack	<a href="#">BMXXSP0800</a>	0.340/ 0.750
	BMXBP0800 rack	<a href="#">BMXXSP1200</a>	0.400/ 0.882
	BMXBP1200 rack BMEXBP1002 rack	<a href="#">BMXXSP3010</a>	0.050/ 0.110
<b>Spring clamping rings</b> Sold in lots of 10	Cables, cross-section 1.5...6 mm <sup>2</sup> /16...10 AWG	<a href="#">STBXSP3010</a>	0.050/ 0.110
	Cables, cross-section 5...11 mm <sup>2</sup> /10...7 AWG	<a href="#">STBXSP3020</a>	0.070/ 0.154
<b>Protective covers</b> (replacement parts) Sold in lots of 5	Unoccupied slots on BMXXBP rack	<a href="#">BMXXEM010</a>	0.005/ 0.011

(1) The grounding terminal is not included in the shielding connection kits.

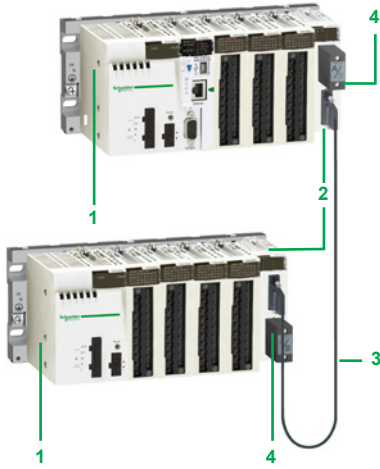

Modicon M340 + expansion rack



Modicon M580 + expansion rack



Modicon X80 drop + expansion rack

### Composition of a multi-rack configuration

Multi-rack configurations are made up of **BM●XBP●●●00** racks (1). They comprise:

- 2 racks maximum for a station with a **BMXP341000** processor
- 4 racks maximum for a station with a **BMXP3420●●●** or **BMXP3420●●●CL** processor
- 4 racks maximum for a station with a **BMEP581020** or **BMEP5820●0** processor
- 8 racks maximum for a station with a **BMEP5830●0**, **BMEP5840●0**, **BMEP585040**, or **BMEP586040** processor

Each rack is equipped with:

- 1 A **BMXCPS●●●●●** power supply or two **BMXCPS4002** redundant power supplies (2)
- 2 A **BMXXBE1000** rack expansion module. This module, inserted in the right-hand end of the rack (**XBE** slot, see page 2/2) does not occupy rack slots 00...11 (4, 6, 8, or 12 slots are still available).
- 3 The **BMXXBE1000** rack expansion modules, which are connected to each other by X-bus cordsets

### X-bus

The racks, distributed on the X-bus, are connected to each other by X-bus extension cordsets 3 with a maximum total length of 30 m/98.42 ft.

The racks are connected in a daisy chain using **BMXXBC●●0K** (3) X-bus extension cordsets connected to the two 9-way SUB-D connectors 7 and 8 on the front panels of the **BMXXBE1000** rack expansion modules 2.

### Line terminators 4

Both expansion modules at the ends of the daisy chain must have a line terminator 4 **TSXTLYEX** on the unused 9-way SUB-D connector.

**Note:** The processor module is always positioned in the rack at address 0. However, in an X-bus daisy chain, the order of the racks has no effect on operation. For example, the order of the daisy chain can be 0-1-2-3, 2-0-3-1, or 3-1-2-0, etc.

### Composition of an expansion backplane configuration

The Modicon M580 standalone processor supports 4 to 8 local racks (depending on the CPU performance level), using existing X80 I/O modules and accessories. The Modicon M580 CPU can be installed in the first rack (0) and this can be a dual bus rack. The M580 PLC will support up to 7 **BMXXBP●●●●●** PV02 or later backplanes (racks) of 4, 6, 8, or 12 slots. The main backplane (rack 0) will support the CPU.

To extend the configuration using additional racks, users can use a bus extender module (**BMXXBE1000**) and X-bus cables. The backplane extender should be plugged into the dedicated connector on the right side of the backplane. It does not occupy any module slot. The XBE extender module is not hot-swappable, like the rest of the X80 I/O platform. Each backplane has to include a power supply module and will support up to 12 modules.

An expansion rack can be connected to the main backplane and the X80 drop (EIO).

The rack address is assigned as follows:

- Each rack will be assigned a physical address using 4 microswitches located in the bus extender module.
- The main rack containing the CPU will be assigned address 0.
- The other racks will be assigned addresses 1 to 7.

Each rack is equipped with:

- 1 A **BMXCPS●●●●●** power supply or two **BMXCPS4002** redundant power supplies (2)
- 2 A **BMXXBE1000** rack expansion module. This module, inserted in the right-hand end of the rack (**XBE** slot) does not occupy rack slots 00...11 (4, 6, 8, or 12 slots are still available).
- 3 The **BMXXBE1000** rack expansion modules, which are connected to each other by X-bus cordsets
- 4 Line terminators: Both expansion modules at the ends of the daisy chain must have a line terminator 4 **TSXTLYEX** on the unused 9-way SUB-D connector.

(1) **BMEXBP●●●●●** is only supported on M580 processor based platforms.

(2) **BMXCPS4002** redundant power supply is only compatible only with the **BMEXBP0602** and **BMEXBP1002** dual power supply backplane.

(3) **BMXXBC●●0K** extension cordsets, length 0.8 m/2.62 ft, 1.5 m/4.92 ft, 3 m/9.84 ft, 5 m/16.4 ft, or 12 m/39.4 ft, with angled connectors or **TSXCBY●08K** extension cordsets, length 1 m/3.28 ft, 3 m/9.84 ft, 5 m/16.4 ft, 12 m/39.4 ft, 18 m/59 ft, or 28 m/92 ft, with straight connectors.

### Ethernet racks

Modicon M580 CPUs support dual bus backplanes (Ethernet and X-bus), as well as Ethernet ring or star architectures on their Ethernet port.

**BME●58●●2●** CPUs support Ethernet star or ring architectures (RSTP loop is supported on ports 2 and 3). The embedded scanner allows scanning of distributed equipment. The CPU directly drives these devices ("NOC" embedded function).

**BME●58●●4●** CPUs support an embedded scanner that allows scanning of X80 drops on Ethernet RIO (EIO) and distributed equipment.

Modicon M580 CPUs have an additional third Ethernet port dedicated to the connection of a service tool such as a PC, HMI, or network analyzer. This port is labeled "ETH 1". It does not support RSTP.

Modicon M580 CPUs can communicate on the main Ethernet backplane. They cannot be installed in an expansion rack.

It is necessary to use an Ethernet backplane:

Reference	Description
<b>BMEXBP0400</b>	Standard 4 -slot backplane
<b>BMEXBP0800</b>	Standard 8-slot backplane
<b>BMEXBP1200</b>	Standard 12-slot backplane
<b>BMEXBP0602</b>	Dual power supply 6-slot backplane
<b>BMEXBP1002</b>	Dual power supply 10-slot backplane
<b>BMEXBP0400H</b>	Ruggedized 4-slot backplane
<b>BMEXBP0800H</b>	Ruggedized 8-slot backplane
<b>BMEXBP1200H</b>	Ruggedized 12-slot backplane
<b>BMEXBP0602H</b>	Ruggedized dual power supply 6-slot backplane
<b>BMEXBP1002H</b>	Ruggedized dual power supply 10-slot backplane

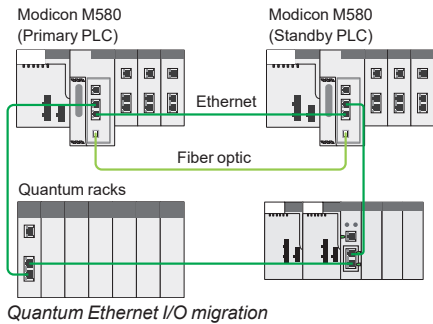

Quantum Ethernet I/O migration

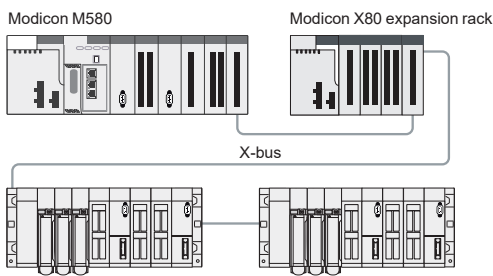

Premium X-bus expansion example

### Quantum Ethernet I/O migration

Modicon M580 CPUs levels 4 and above (**BMEP584040**, **BMEP585040**, and **BMEP586040**) support Quantum I/O using the Quantum Ethernet remote drop adapter **140CRA31200**. The number of Remote I/O drops allowed (up to 31) depends on the M580 processor model.

The Quantum Ethernet drop is configured using EcoStruxure Control Expert (1) software. Each Quantum I/O can be configured with the X80 I/O model (Device DDT) or the Quantum model ("State ram" :%I, %IW, %M, %MW) to simplify the reuse of legacy applications.

The compatibilities of Quantum I/O in an Ethernet Quantum drop are identical in a Quantum processor based architecture. See [page 1/8](#) for more information.

In addition, the Modicon LL984 legacy language is supported by some CPU models; please refer to the M580 product catalog for more information.

### Premium X-bus extension: making migration as simple as possible

The Modicon M580 CPU supports revamping of an existing Premium installation by replacing the Premium rack 0 (CPU and communication modules) with an M580 rack. It is also possible to combine Premium racks **TSXRKY4EX/6EX/8EX/12EX** with X80 I/O based on an X-bus rack. The majority of existing configurations are supported. The number of expanded racks allowed depends on which CPU is being used:

- The **BMEP581020**, **BMEP582020**, and **BMEP582040** CPUs support a main local rack and up to 3 expansion racks. If you are using 4, 6, or 8-slot Premium expansion racks, you can install 2 physical racks at each assigned rack address, allowing up to 6 Premium expansion racks (up to 6 backplanes and 100 m/328 ft between 2 drops).

- The **BMEP583020**, **BMEP583040**, **BMEP584020**, and **BMEP584040** CPUs support a main local rack with up to 7 expansion racks. If you are using 4, 6, or 8-slot Premium expansion racks, you can install 2 physical racks at each assigned rack address, allowing up to 14 Premium expansion racks.

The maximum number of supported X-bus drops is as follows:

- 4 for **BMEP581000/2000**
- 8 for **BMEP583000/4000**

The maximum number of X-bus drops is calculated as follows:

- Max number = 1 (CPU rack: **BMXXBP0000** or **BMEXP0000**) + ½ the number of **TSXRKY4/6/8EX** racks + the number of **TSXRKY12EX** racks + the number of **BMXXBP0000** racks

### Description

The front panel of the **BMXXBE1000** rack expansion module comprises:

**5** A screw for locking the module in its slot (at the far right-hand end of the rack)

**6** A display block with 5 LEDs:

- RUN LED (green): Module running
- COL LED (red): Several racks have the same address, or rack address 0 does not contain the **BMXP340000** or **BMXP580000** processor module
- LEDs 0, 1, 2, and 3 (green): rack address 0, 1, 2, or 3

**7** A 9-way female SUB-D connector, marked X-bus, for the incoming X-bus cordset **3** connected to the upstream rack, or if it is the first rack, for the **A/** line terminator included in the **TSXTLYEX 4** pack

**8** A 9-way female SUB-D connector, marked X-bus, for the outgoing X-bus cordset **3** to the downstream rack, or if it is the last rack, for the **B/** line terminator included in the **TSXTLYEX 4** pack

#### On the right-hand side panel

A flap for accessing the 3 rack addressing microswitches: 0...3

#### Installation rules for **BM0XBP0000** racks

Rules for installing racks in enclosures (see our website [www.schneider-electric.com](http://www.schneider-electric.com)).

(1) EcoStruxure Control Expert software continues the Unity Pro range of software and corresponds to versions ≥ 14 of Unity Pro.

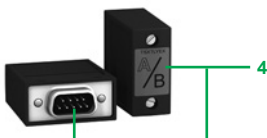
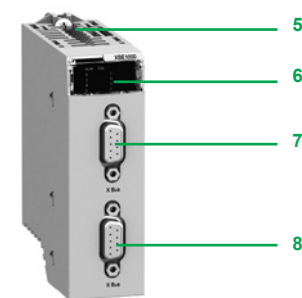



BMXXBE1000

Rack expansion			
Description	Use	Reference	Weight kg/lb
<b>Modicon X80 I/O rack expansion module</b>	Standard module for mounting in each rack (XBE slot) and used to interconnect: - Up to 2 racks with BMXP341000 processor module - Up to 4 racks with BMXP342000 processor module - Up to 3 racks with BMEP581020/20000 processor module - Up to 7 racks with BMEP583000/40000/50000/60000 processor module - 1 rack with X80 drop (EIO)	<b>BMXXBE1000</b>	0.178/ 0.392
<b>Modicon X80 I/O rack expansion kit</b>	Complete kit for 2-rack configuration comprising: - 2 BMXXBE1000 rack expansion modules - 1 BMXXBC008K extension cordset, length 0.8 m/2.62 ft - 1 TSXTLYEX line terminator (set of 2)	<b>BMXXBE2005</b>	0.700/ 1.543



BMXXBC008K

Cordsets and connection accessories						
Description	Use	Composition	Type of connector	Length m/ft	Reference	Weight kg/lb
<b>X-bus expansion cordsets</b> total length 30 m/98 ft max.	Between 2 BMXXBE1000 rack expansion modules	2 x 9-way SUB-D connectors	Angled	0.8/	<b>BMXXBC008K</b>	0.165/
				2.62		0.363
				1.5/	<b>BMXXBC015K</b>	0.250/
				4.92		0.551
				3/	<b>BMXXBC030K</b>	0.420/
				9.84		0.926
				5/	<b>BMXXBC050K</b>	0.650/
				16.4		1.433
				12/	<b>BMXXBC120K</b>	1.440/
				39.4		3.175
			Straight	1/	<b>TSXCBY010K</b>	0.160/
				3.28		0.353
				3/	<b>TSXCBY030K</b>	0.260/
				39.4		0.573
				5/	<b>TSXCBY050K</b>	0.360/
				16.4		0.794
				12/	<b>TSXCBY120K</b>	1.260/
				39.4		2.778
				18/	<b>TSXCBY180K</b>	1.860/
				59		4.101
28/	<b>TSXCBY280KT</b>	2.860/				
92	(1)	6.305				



TSXTLYEX

<b>Cable reel</b>	Length of cable to be equipped with TSXCBYK9 connectors	Cable with ends with flying leads, 2 line testers	-	100/ 328	<b>TSXCBY1000</b>	12.320/ 27.161
-------------------	---	---	---	-------------	-------------------	-------------------

Description	Use	Composition	Sold in lots of	Reference	Weight kg/lb
<b>Line terminators</b>	Required on both BMXXBP0000 modules located at either end of the daisy chain	2 x 9-way SUB-D connectors marked A/ and /B	2	<b>TSXTLYEX</b>	0.050/ 0.110
<b>X-bus straight connectors</b>	For TSXCBY1000 cables	2 x 9-way SUB-D straight connectors	2	<b>TSXCBYK9</b>	0.080/ 0.176
<b>Connector assembly kit</b>	For fixing TSXCBYK9 connectors	2 crimping pliers, 1 pen (1)	-	<b>TSXCBYACC10</b>	-

(1) To fix the connectors to the cable, you also need a wire stripper, a pair of scissors, and a digital ohmmeter.



### Presentation

**BMXCPS●●●●** power supply modules provide the power supply for each **BMEXBP●●00** or **BMXXBP●●00** Modicon X80 I/O rack and the modules installed on it (**BMEXBP●●02** supports **BMXCPS●●●●2** modules only).

The Modicon X80 I/O power supply module offer comprises:

- Five power supply modules for DC line supplies:
  - 24 V  $\overline{\text{---}}$ , 17 W isolated power supply module, **BMXCPS2010**
  - 24...48 V  $\overline{\text{---}}$ , 32 W isolated power supply module, **BMXCPS3020**
  - 24...48 V  $\overline{\text{---}}$ , 40 W redundant power supply module, **BMXCPS4022**
  - 125 V  $\overline{\text{---}}$ , 36 W power supply module, **BMXCPS3540T** (extended operating temperature -25 to +70 °C/-13 to +158 °F)
  - 125 V  $\overline{\text{---}}$ , 40 W redundant power supply module, **BMXCPS3522**
- Three power supply modules for AC line supplies:
  - 100...240 V  $\sim$ , 20 W power supply module, **BMXCPS2000**
  - 100...240 V  $\sim$ , 36 W power supply module, **BMXCPS3500**
  - 100...240 V  $\sim$ , 40 W redundant power supply module, **BMXCPS4002**

### Description

The power supply module is selected according to:

- The electrical line supply: 24 V  $\overline{\text{---}}$ , 48 V  $\overline{\text{---}}$ , 125 V  $\overline{\text{---}}$ , or 100...240 V  $\sim$
- The required power (see the power consumption table available on our website [www.schneider-electric.com](http://www.schneider-electric.com)) (1)

**BMXCPS●●●●** power supply modules have the following on the front panel:

- 1 A display block comprising:
  - OK LED (green), lit if rack voltages are present and correct
  - 24 V LED (green), lit when the sensor voltage is present (BMXCPS2000/3500/3540T power supply modules only)
  - RD LED (green), lit when all the internal power supply modules are functioning normally (BMXCPS4002/BMXCPS4022/BMXCPS3522 redundant power supply modules only)
  - ACT LED (green), lit when the power supply is the Master power supply, off when it acts as a slave supply in redundant application (BMXCPS4002/BMXCPS4022/BMXCPS3522 redundant power supply modules only)
- 2 A pencil-point RESET pushbutton for a cold restart of the application
- 3 A 2-way connector that can take a removable terminal block (caged or spring-type) for connecting the alarm relay
- 4 A 5-way connector that can take a removable terminal block (caged or spring-type) for connecting the following:
  - $\overline{\text{---}}$  or  $\sim$  line supply
  - Protective ground
  - Dedicated 24 V  $\overline{\text{---}}$  power supply for the input sensors (for BMXCPS2000/3500/3540T power supply modules only)

**Included with each power supply module:**

- Set of two caged removable terminal blocks (5-way and 2-way) **BMXXTSCPS10**

**To be ordered separately** (if necessary):

- Set of two spring-type removable terminal blocks (5-way and 2-way) **BMXXTSCPS20**

### Compatibility of the power supply with the rack

The redundant AC power supply can be used alone in a single power supply rack or as a pair in a dual power supply rack. For high-availability applications, two independent redundant power supplies can be used to increase the security of power supply. In case the master power supply fails to provide the total current, the slave power supply will change to master mode and continue to function.

Type	Standalone power supply (BMXCPS●●●0)	Redundant power supply (BMXCPS●●●2)
Single power supply racks (BMXXBP●●00, BMEXBP●●00)		
Dual power supply racks (BMEXBP●●02)		

- Compatible
- Incompatible

(1) This power consumption calculation for the rack can also be performed by EcoStruxure Control Expert V14 (Unity Pro in earlier versions) programming software.

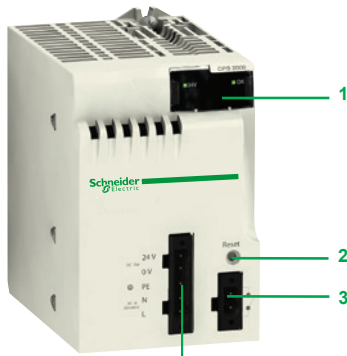

BMXCPS2000

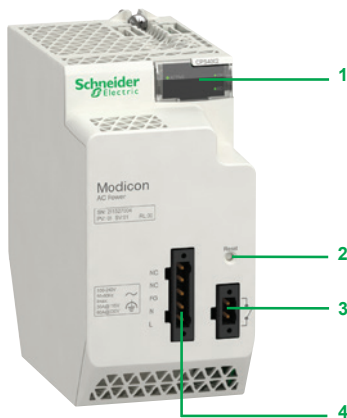

BMXCPS4002



BMXCPS2010/3020



BMXCPS2000/3500



BMXCPS4002



BMXCPS4022



BMXCPS3522

### Functions

#### Alarm relay

The alarm relay incorporated in each power supply module has a volt-free contact accessible on the front panel, on the 2-way connector.

The operating principle is as follows:

In normal operation, with the PLC in RUN, the alarm relay is energized and its contact is closed (state 1).

The relay de-energizes and its associated contact opens (state 0) whenever the application stops, even partially, due to any of the following:

- Detection of a blocking fault
- Incorrect rack output voltages
- Loss of supply voltage

#### RESET pushbutton

The power supply module in each rack has a RESET button on the front panel which, when pressed, triggers an initialization sequence on the processor and the modules in the rack it supplies.

Pressing this pushbutton triggers a sequence of service signals, which is the same as that for:

- A power break, when the pushbutton is pressed
- A power-up, when the pushbutton is released

In terms of the application, these operations represent a cold start (forcing the I/O modules to state 0 and initializing the processor).

#### Sensor power supply

**BMXCPS2000/3500** AC power supply modules and **BMXCPS3540T** DC power supply modules have an integrated 24 V  $\bar{\bar{}}$  supply for powering the input sensors.

Connection to this 24 V  $\bar{\bar{}}$  sensor power supply is via the 5-way connector on the front panel. The available power depends on the power supply module (0.45 A or 0.9 A).

### References

Each **BMEXBP●●00** or **BMXXBP●●00** rack must be equipped with a power supply module. **BMEXBP●●02** must be equipped with 1 or 2 redundant power supply modules. These modules are inserted in the leftmost power supply slots of each rack (marked CPS).

The power required to supply each rack depends on the type and number of modules installed in the rack. It is therefore necessary to draw up a power consumption table for each rack in order to determine which

**BMXCPS●●●●** power supply module is the most suitable for each rack (please consult our website [www.schneider-electric.com](http://www.schneider-electric.com)).

#### Power supply modules (1)

Line supply	Available power (2)				Nominal current 24 V $\bar{\bar{}}$ rack (3)	Reference	Weight kg/lb
	3.3 V $\bar{\bar{}}$ (3)	24 V $\bar{\bar{}}$ rack (3)	24 V $\bar{\bar{}}$ sensors (4)	Total			
24 V $\bar{\bar{}}$ isolated	8.3 W	17 W	–	17 W	0.7 A	<a href="#">BMXCPS2010</a>	0.290/ 0.639
24...48 V $\bar{\bar{}}$ isolated	15 W	32 W	–	32 W	1.3 A	<a href="#">BMXCPS3020</a>	0.340/ 0.750
24...48 V $\bar{\bar{}}$	18 W	40 W	–	40 W	1.67 A	<a href="#">BMXCPS4022</a>	0.810/ 1.786
100...150 V $\bar{\bar{}}$	15 W	31.2 W	21.6 W	36 W (5)	1.3 A	<a href="#">BMXCPS3540T</a> (5)	0.340/ 0.750
	180 W	40 W	–	40 W	1.67 A	<a href="#">BMXCPS3522</a>	0.610/ 1.345
100...240 V $\sim$	8.3 W	16.8 W	10.8 W	20 W	0.7 A	<a href="#">BMXCPS2000</a>	0.300/ 0.661
	15 W	31.2 W	21.6 W	36 W	1.3 A	<a href="#">BMXCPS3500</a>	0.360/ 0.794
	18 W	40 W	–	40 W	1.67 A	<a href="#">BMXCPS4002</a>	0.360/ 0.794

#### Separate parts

Description	Type	Composition	Reference	Weight kg/lb
Set of 2 removable connectors	Spring-type	One 5-way terminal block and one 2-way terminal block	<a href="#">BMXXTSCPS20</a>	0.015/ 0.033
	Caged	One 5-way terminal block and one 2-way terminal block	<a href="#">BMXXTSCPS10</a>	0.020/ 0.044

(1) Include a set of 2 caged removable connectors. Spring-type connectors available separately under reference [BMXXTSCPS20](#).

(2) The sum of the power consumed on each voltage (3.3 V  $\bar{\bar{}}$  and 24 V  $\bar{\bar{}}$ ) must not exceed the total power of the module. See the power consumption table available on our website [www.schneider-electric.com](http://www.schneider-electric.com).

(3) 3.3 V  $\bar{\bar{}}$  and 24 V  $\bar{\bar{}}$  rack voltages for powering modules in the Modicon X80 I/O rack.

(4) 24 V  $\bar{\bar{}}$  sensor voltage for powering the input sensors (voltage available via the 2-way removable connector on the front panel).

(5) Extended operating temperature -25 to +70 °C/-13 to +158 °F (with power derating at extreme temperatures: 27 W between -25 and 0 °C/-13 and 0 °F and between 60 and 70 °C/140 and 158 °F).



## X80 discrete I/O modules

- [Selection guide](#) ..... page 3/2
- [Presentation, description](#) ..... page 3/8
- [Connections](#) ..... page 3/9
- [Functions](#) ..... page 3/10
- [Complementary characteristics](#) ..... page 3/11
- [References](#) ..... page 3/12

## X80 analog I/O modules

- [Selection guide](#) ..... page 3/14
- [Presentation](#) ..... page 3/18
- [Description](#) ..... page 3/19
- [Connections, combinations](#) ..... page 3/20
- [Complementary characteristics](#) ..... page 3/21
- [References](#) ..... page 3/22

## X80 HART analog I/O modules

- [Selection guide](#) ..... page 3/24
- [Presentation, description](#) ..... page 3/26
- [References](#) ..... page 3/27

## X80 counter modules

- [Presentation, description](#) ..... page 3/28
- [Functions](#) ..... page 3/29
- [References](#) ..... page 3/31

## X80 time-stamping module

- [Presentation, description](#) ..... page 3/32
- [Performance, references](#) ..... page 3/33

## X80 SSI encoder interface module

- [Presentation, description](#) ..... page 3/34
- [Functions, references](#) ..... page 3/35

## X80 motion control module

- [Presentation, description](#) ..... page 3/36
- [Operation, references](#) ..... page 3/37
- [MFB presentation, functions](#) ..... page 3/38
- [Motion tree manager, programming, maintenance](#) ..... page 3/39

## X80 frequency input module

- [Presentation, description](#) ..... page 3/40
- [Module specifications, references](#) ..... page 3/41



# Modicon X80 modules platform

## Discrete I/O modules

### Input modules

#### Applications

8-channel input modules	16-channel input modules
Connection via caged, screw clamp, or spring-type removable block terminal	



<b>Type</b>	~	~	---
<b>Voltage</b>	200...240 V	100...120 V	24 V      48 V
<b>Current per channel</b>	10.4 mA (for U = 220 V to 50 Hz)	5 mA	3.5 mA      2.5 mA
<b>Modularity</b> (Number of channels and commons)	8 isolated inputs and 1 common	8 isolated channels and no common point	16 isolated inputs and 1 common
<b>Connection</b>	Via 20-way caged, screw clamp, or spring-type removable terminal block BMXFTB2000/2010/2020		
<b>Isolated inputs</b>	IEC/EN 61131-2 conformity	Type 2	Type 3
Logic	–	–	Positive ( <i>sink</i> )
Type of input	Capacitive	Capacitive	Current sink
Sensor compatibility IEC/EN 60947-5-2	2-wire ~	2-wire ~	2-wire ---, 3-wire --- PNP any type
<b>Sensor power supply</b> (ripple included)	170...264 V	85...132 V (no sensor power monitoring)	19...30 V      38...60 V
<b>Protection of inputs</b>	Use one 0.5 A fast-blow fuse per group of channels	Use one 0.25 A fast-blow fuse per channel	Use one 0.5 A fast-blow fuse per group of channels
<b>Maximum dissipated power</b>	4.73 W	2.35 W	2.5 W      3.6 W
<b>Operating temperature</b>	0...60 °C/32...140 °F		
<b>Compatibility with TeSys Quickfit installation system</b>	–		
<b>Compatibility with Modicon Telefast ABE7 pre-wired system</b>	Passive connection sub-bases	–	
	Adapter sub-bases with relays	–	

<b>References</b>	<b>BMXDAI0805</b>	<b>BMXDAI0814</b>	<b>BMXDDI1602</b>	<b>BMXDDI1603</b>
-------------------	-------------------	-------------------	-------------------	-------------------

Pages 3/12

16-channel input modules					
Connection via caged, screw clamp, or spring-type removable block terminal			Connection via caged or spring-type removable block terminal		Connection via caged, screw clamp, or spring-type removable block terminal



~ or ---	~	---			
24 V (~ or ---)	48 V	100...120 V	100...120 V ~	200...240 V ~	125 V
3 mA (~ or ---)	5 mA		2...15 mA	3...15 mA	2.4 mA
16 isolated inputs and 1 common	16 isolated inputs		16 isolated inputs and 1 common		
Via BMXFTB2000/2010/2020 20-way caged, screw clamp, or spring-type removable block terminal			Via BMXFTB4000/4020 40-way caged, or spring-type removable block terminal		Via BMXFTB2000/2010/2020 20-way caged, screw clamp, or spring-type removable block terminal
Type 1 (~)	Type 3		Type 1		
Negative ( <i>source</i> ) (---)	–		Positive ( <i>sink</i> )		
Resistive	Capacitive		Current sink		
2-wire ---/~, 3-wire --- PNP or NPN any type	2-wire ~		2-wire, 3-wire		–
19...30 V --- 20...26 V ~	40...52 V	85...132 V	100...120 V ~	200...240 V ~	88...150 V
Use one 0.5 A fast-blow fuse per group of channels			Use one 0.25 A fast-blow fuse per channel	Use one 0.5 A fast-blow fuse per group of channels	
3 W	4 W	3.8 W	4.3 W	8.5 W (at 40 °C/104 °F)	
0...60 °C/32...140 °F					
–					
–					
–					

<b>BMXDAI1602</b>	<b>BMXDAI1603</b>	<b>BMXDAI1604</b>	<b>BMXDAI1614</b>	<b>BMXDAI1615</b>	<b>BMXDDI1604T</b>
-------------------	-------------------	-------------------	-------------------	-------------------	--------------------

Pages 3/12

# Modicon X80 modules platform

Discrete I/O modules  
Input modules and mixed I/O modules

## Applications

## 32- or 64-channel high-density input modules

Connection via 40-way connectors with preassembled cordsets



<b>Type</b>		---	
<b>Voltage</b>		24 V	
<b>Current per channel</b>	Inputs	2.5 mA	1 mA
	Outputs	–	–
<b>Modularity</b> (Number of channels and commons)		32 isolated inputs and 2 commons	64 isolated inputs and 4 commons
<b>Connection</b>		Via one 40-way connector	Via two 40-way connectors
<b>Isolated inputs</b>	IEC/EN 61131-2 conformity	Type 1	Non-IEC
	Logic	Positive (sink)	
	Type of input	Current sink	
	Sensor compatibility IEC/EN 60947-5-2	2-wire ---, 3-wire --- PNP any type	–
<b>Sensor power supply</b> (ripple included)		19...30 V	
<b>Protection of inputs</b>		Use one 0.5 A fast-blow fuse per group of channels	
<b>Isolated outputs</b>	Fallback	–	
	IEC/EN 61131-2 conformity	–	
	Protection	–	
<b>Preactuator power supply</b> (ripple included)		–	
<b>Output fuse protection</b>		–	
<b>Maximum dissipated power</b>		3.9 W	4.3 W
<b>Operating temperature</b>		0...60 °C/32...140 °F	
<b>Compatibility with TeSys Quickfit installation system</b>		LU9 G02 splitter boxes (8 motor starters) and BMXFCC●●1/●●3 preassembled cordsets (see pages 3/9 and 3/13)	
<b>Compatibility with Modicon Telefast ABE7 pre-wired system (1)</b>	Passive connection sub-bases	Depending on model, 8- or 16-channel passive sub-bases, with or without LED, with common or 2 terminals per channel	
	Adapter sub-bases with relays	Depending on model, active sub-bases with solid state or electromagnetic relays (fixed or removable), 16 channels, with common or 2 terminals per channel (screw or spring-type connection)	

## References

<b>BMXDDI3202K</b>	<b>BMXDDI6402K</b>
--------------------	--------------------

## Pages

3/12

(1) For more information, please refer to the "Telefast Pre-wired system – Modicon ABE7 IP20 connection sub-bases" catalog or visit our website [www.schneider-electric.com](http://www.schneider-electric.com).

## 16- or 32-channel mixed I/O modules

Connection via caged, screw clamp, or spring-type removable block terminal



---		--- and ~ (outputs only)	---
Inputs: 24 V --- Solid-state outputs: 24 V 3.5 mA		Inputs: 24 V --- Relay outputs: 24 V --- or 24...240 V ~ 3.5 mA	Inputs: 24 V --- Solid-state outputs: 24 V 2.5 mA
0.5 A		2 A (--- or ~)	0.1 A
8 isolated inputs and 1 common, 8 isolated outputs and 1 common		16 isolated inputs and 1 common, 16 isolated outputs and 1 common	
Via BMXF2000/2010/2020 20-way caged, screw clamp, or spring-type removable terminal block Type 3		Via one 40-way connector	
Positive (sink)		–	Positive (sink)
Current sink		Current sink	
2-wire ---, 3-wire --- PNP any type		2-wire ---, 3-wire --- PNP any type	
19...30 V		19...30 V	
Use one 0.5 A fast-blow fuse per group of channels		Use one 0.5 A fast-blow fuse per group of channels	
Configurable output fallback, continuous monitoring of output control, and resetting of outputs in case of internal detected fault			
Yes		Protected	
Protected		Not protected	Protected
Positive		–	Positive
19...30 V		19...30 V --- 24...240 V ~	19...30 V
Use a 2 A fast-blow fuse		Use a 12 A fast-blow fuse	Use a 2 A fast-blow fuse
3.7 W		3.1 W	4 W
0...60 °C/32...140 °F		0...60 °C/32...140 °F	
–		LU9 G02 splitter boxes (8 motor starters) and BMXFCC●●1/●●3 preassembled cordsets (see pages 3/9 and 3/13)	
–		Depending on model, 8- or 16-channel passive sub-bases, with or without LED, with common or 2 terminals per channel	
–		Depending on model, active sub-bases with solid state or electromagnetic relays (fixed or removable), 16 channels, with common or 2 terminals per channel (screw or spring-type connection)	

## References

<b>BMXDDM16022</b>	<b>BMXDDM16025</b>	<b>BMXDDM3202K</b>
--------------------	--------------------	--------------------

## Pages

3/13

# Modicon X80 modules platform

Discrete I/O modules

Output modules

## Applications

## 32- or 64-channel high-density output modules

Connection via 40-way connectors with preassembled cordsets



<b>Type</b>	--- transistor	
<b>Voltage</b>	24 V	
<b>Current per channel</b>	0.1 A	
<b>Modularity</b> (Number of channels and commons)	32 protected outputs and 2 commons	64 protected outputs and 4 commons
<b>Connection</b>	Via one 40-way connector	Via two 40-way connectors
<b>Outputs</b>	Configurable output fallback, continuous monitoring of output control, and resetting of outputs in case of internal detected fault	
<b>Fallback</b>	Yes	
<b>IEC/EN 61131-2 conformity</b>	Yes	
<b>Protection</b>	Positive	
<b>Logic</b>		
<b>Preactuator power supply</b> (ripple included)	19...30 V ---	
<b>Output fuse protection</b>	Use one 2 A fast-blow fuse per group of channels	
<b>Maximum dissipated power</b>	3.6 W	6.85 W
<b>Operating temperature</b>	0...60 °C/32...140 °F	
<b>Compatibility with TeSys Quickfit installation system</b>	LU9 G02 splitter boxes (8 motor starters) and BMXFCC●●1/●●3 preassembled cordsets (see pages 3/9 and 3/13)	
<b>Compatibility with Modicon Telefast ABE7 pre-wired system (1)</b>	Passive connection sub-bases	Depending on model, passive sub-bases with 8- or 16 channels, with or without LED, with common or with 2 terminals per channel
	Adapter sub-bases with relays	Depending on model, active sub-bases with solid state or electromagnetic relays (fixed or removable). 16 channels with 1 common or 2 terminals per channel, screw or spring-type connection

<b>References</b>	<b>BMXDDO3202K</b>	<b>BMXDDO6402K</b>
-------------------	--------------------	--------------------

**Pages** 3/12

(1) For more information, please refer to the "Telefast Pre-wired system -- Modicon ABE7 IP20 connection sub-bases" catalog or visit our website [www.schneider-electric.com](http://www.schneider-electric.com).

## 8- or 16-channel output modules

Connection via caged, screw clamp, or spring-type removable block terminal



--- transistor	~ triac	--- relay	---/~ relay				
24 V	100...240 V	24...240 V	100...150 V	24 V ---, 24...240 V ~	24...240 V ~/ 24...125 V ---	24 V ---, 24...240 V ~	24...240 V ~/ 24...125 V ---
0.5 A	0.6 A	3 A	0.3 A (lth)	2 A (lth)	2 A (lth)	2 A (lth)	2 A (lth)
16 protected outputs and 1 common	16 non-protected outputs and 4 commons	16 isolated outputs	8 non-protected outputs, without common	8 normally open isolated relay outputs	16 non-protected outputs and 2 commons	8 normally open/ normally closed isolated relay outputs	
Via BMXF TB2000/2010/2020 20-way caged, screw clamp, or spring-type removable block terminal	Via BMXF TB4000/4020 40-way caged or spring-type removable block terminal	Via BMXF TB2000/2010/2020 20-way caged, screw clamp, or spring-type removable block terminal	Via BMXF TB2000/2010/2020 20-way caged, screw clamp, or spring-type removable block terminal	Via BMXF TB4000/4020 40-way caged or spring-type removable block terminal			
Configurable output fallback, continuous monitoring of output control, and resetting of outputs in case of internal detected fault	Configurable output fallback						
Yes	-						
Positive (source)	Negative (sink)	-					
19...30 V	100...240 V	24...240 V	100...150 V	19...30 V --- 24...240 V ~	19...264 V ~ 5...150 V ---	19...30 V --- 24...240 V ~	19...264 V ~ 5...150 V ---
Use one 6.3 A fast-blow fuse per group of channels	Use one 3 A fast-blow fuse per group of channels	Use one 4 A fast-blow fuse per channel or per group of channels	Use one 0.5 A, 250 V DC fast-blow fuse on each relay	Use one 3 A fast-blow fuse on each channel	Use one fast-blow fuse for each output channel	Use one 12 A fast-blow fuse on each group of channels	Use one fast-blow fuse for each output channel
4 W	2.26 W	-	3.17 W	2.7 W	3.6 W	3 W	3.6 W
0...60 °C/32...140 °F			-25...70 °C/ -13...158 °F		0...60 °C/32...140 °F		
-							
-							
-							

<b>BMXDDO1602</b>	<b>BMXDDO1612</b>	<b>BMXDAO1605</b>	<b>BMXDAO1615</b>	<b>BMXDRA0804T</b>	<b>BMXDRA0805</b>	<b>BMXDRA0815</b>	<b>BMXDRA1605</b>	<b>BMXDRC0805</b>
-------------------	-------------------	-------------------	-------------------	--------------------	-------------------	-------------------	-------------------	-------------------

**Pages** 3/12

### Presentation

Discrete I/O modules in the Modicon X80 I/O offer are standard modules occupying a single slot on the rack. These modules are equipped with either of the following:

- A connector for a screw or spring-type 20-way removable terminal block
- One or two 40-way connectors

This wide range of discrete I/O can be used to meet whatever requirements arise in terms of:

- Functions: AC or DC I/O, positive or negative logic
- Modularity: 8, 16, 32, or 64 channels per module

The inputs receive signals from the sensors and perform the following functions:

- Acquisition
- Adaptation
- Electrical isolation
- Filtering
- Protection against interference signals

The outputs memorize commands issued by the processor to enable control of the preactuators via the decoupling and amplification circuits.

### Description

**BMXD●/D●O/DRA** discrete I/O modules are standard format (1 slot). They have an IP20 case to help protect the electronics, and are locked into position with a captive screw.

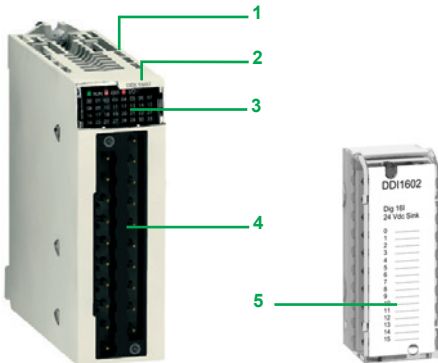

Module for connection via 20-way removable terminal block

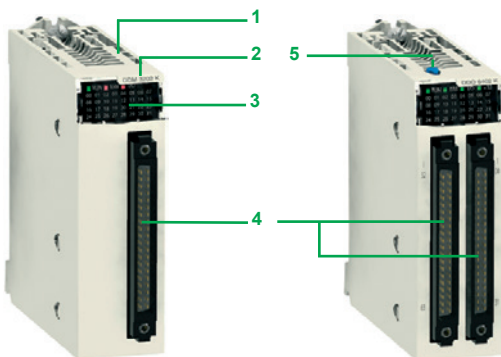

32- and 64-channel modules for connection via one or two 40-way connector(s)

#### I/O modules connected via 20-way removable terminal block

- 1 Rigid body providing support and protection for the electronic card
- 2 Module reference marking (a label is also visible on the right-hand side of the module)
- 3 Channel status display block
- 4 Connector taking the 20-way removable terminal block for connection of sensors or preactuators

To be ordered separately:

- 5 **BMXFTB20●0** 20-way removable terminal block (identification label supplied with each I/O module) or a preassembled cordset with a 20-way removable terminal block at one end and flying leads at the other (see [page 3/9](#)).

#### I/O modules connected via 40-way connector(s)

- 1 Rigid body providing support and protection for the electronic card
- 2 Module reference marking (a label is also visible on the right-hand side of the module)
- 3 Channel status display block
- 4 One or two 40-way connectors (32 or 64 channels) (1) for connection of sensors or preactuators
- 5 With the 64-channel module, a pushbutton which, with successive presses, displays the state of channels 0...31 or 32...63 on the display block 3 (see [page 3/10](#))

To be ordered separately, depending on the type of module:

One or two preassembled cordset(s) with a 40-way connector (see [page 3/9](#))

(1) Fujitsu FCN 40-way connector



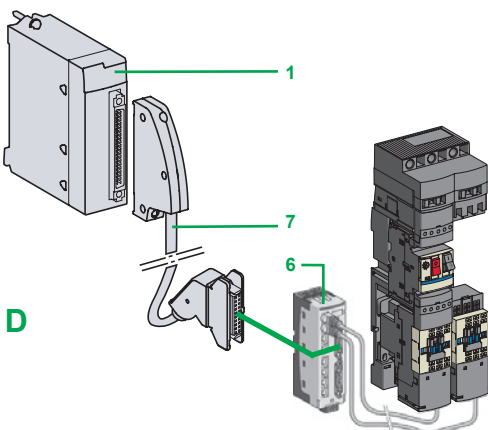
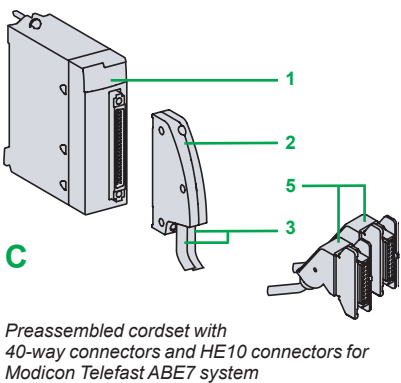
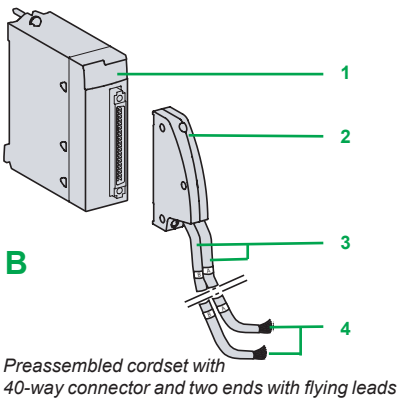
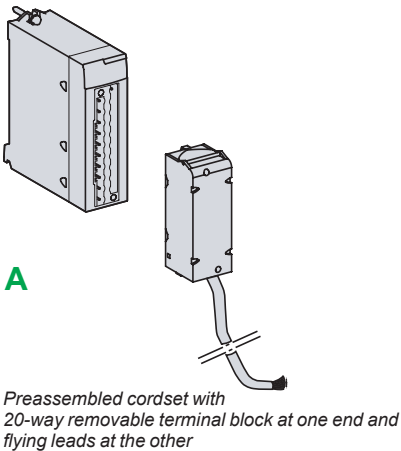

Example of connection to the TeSys Quickfit installation system

### Connecting modules with removable terminal blocks

There are three types of 20-way removable terminal block:

- Screw clamp terminal block
- Caged terminal block
- Spring-type terminal block

Each removable terminal block can take:

- Bare wires
- Wires equipped with **DZ5CE** cable ends

**A:** One version of the removable terminal block is equipped with 3, 5, or 10 m / 4.92, 9.84, or 16.4 ft cordsets with color-coded flying leads (**BMXFTW●●1**). Use limited to voltages of  $\leq 48$  V.

### Caged terminal blocks

The capacity of each terminal is:

- Minimum: One 0.34 mm<sup>2</sup> wire (AWG 22)
- Maximum: One 1 mm<sup>2</sup> wire (AWG 18)

**BMXFTB2000** caged connectors are equipped with captive screws (maximum tightening torque 0.5 N.m/0.37 lb-ft).

### Screw clamp terminal blocks

The capacity of each terminal is:

- Minimum: One or two 0.34 mm<sup>2</sup> wires (AWG 22)
- Maximum: Two 1.5 mm<sup>2</sup> wires (AWG 15)

**BMXFTB2010** screw clamp connectors are equipped with captive screws (maximum tightening torque 0.5 N.m/0.37 lb-ft).

### Spring terminals

The capacity of each terminal in the **BMXFTB2020** spring-type terminal blocks is:

- Minimum: One 0.34 mm<sup>2</sup> wire (AWG 22)
- Maximum: One 1 mm<sup>2</sup> wire (AWG 18)

### Connecting modules with 40-way connectors

#### Preassembled cordsets with 40-way connector at one end and flying leads at the other

**B:** Preassembled cordsets can be used for easy direct wire-to-wire connection between the I/O of modules with 40-way connectors **1** and the sensors, preactuators, or intermediate terminal blocks.

These preassembled cordsets comprise:

- At one end, a 40-way connector **2** with either of the following:
  - One sheath containing 20 wires with a cross-section of 0.34 mm<sup>2</sup> (AWG 22) (**BMXFCW●●1**)
  - Two sheaths **3**, each containing 20 wires with a cross-section of 0.34 mm<sup>2</sup> (AWG 22) (**BMXFCW●●3**)
- At the other end, color-coded flying leads **4** conforming to standard DIN47100

#### Preassembled cordsets with 40-way connector and HE 10 connector(s)

**C:** Two types of cordset can be used for connecting the I/O of modules **1** with 40-way connectors to Modicon Telefast ABE7 rapid wiring connection and adaptation interfaces (**1**).

These preassembled cordsets comprise:

- At one end, a 40-way connector **2** with either of the following:
  - One sheath containing 20 wires (**BMXFCC●●1**)
  - Two sheaths **3** each containing 20 wires (**BMXFCC●●3**)
- At the other end, one or two HE 10 connectors **5**

### Connection to TeSys Quickfit system

**D:** **1** **BMXDDI3202K/6402K** input modules, **BMXDDO3202K/6402K** output modules, and **BMXDDM3202K** mixed I/O modules with 40-way connectors are designed, amongst other things, for use in conjunction with the TeSys Quickfit mounting system via the **LU9G02** splitter module **6** (for 8 motor starters).

The splitter modules are easily connected using **7** **BMXFCC●●1/●●3** preassembled cordsets.

(1) For more information, please refer to the "Telefast Pre-wired system -- Modicon ABE7 IP20 connection sub-bases" catalog or visit our website [www.schneider-electric.com](http://www.schneider-electric.com).

### Functions (1)

The discrete I/O modules provide the following functions:

- **Hot swapping:** Due to their special integrated devices, I/O modules (including application-specific modules) can be removed or added while the power is on.
- **I/O assignment:** The channels of discrete I/O modules are grouped into blocks of 4, 8, or 16 consecutive channels depending on the type of module. Each group of channels can be assigned to a specific application task, namely master or fast.
- **Protection of DC inputs:** The 24 V  $\overline{\text{DC}}$  and 48 V  $\overline{\text{DC}}$  inputs are constant-current type. This characteristic limits the current consumed at the inputs.
- **Protection of DC outputs:** Active transistor outputs can withstand overloads, short-circuits, reverse polarity, and inductive over-voltage.
- **Reactivation of DC outputs:** If a line fault has caused an output to trip, the output can be reactivated using this parameter if no other terminal line fault is present. Reactivation is controlled by means of a group of 8 channels. It can be programmed or automatic.
- **RUN/STOP command:** An input can be configured to control the RUN/STOP changeover for the PLC.
- **Output fallback:** This parameter defines the fallback mode used by the DC transistor outputs when the PLC stops. It can assume the “fallback” value at state 0 or state 1 for the corresponding group of 8 channels or the “maintain” value representing the state of the outputs before the PLC stops.
- **I/O module diagnostics:** Each discrete I/O module is equipped with a display block on the front panel centralizing the information necessary for module control, diagnostics, and maintenance.

#### Diagnostics via EcoStruxure Control Expert (2):

Using the integrated diagnostics in EcoStruxure Control Expert (2), local diagnostics screens are available at global hardware configuration level, module level, and channel level.

#### Remote diagnostics using a Web browser on a “Thin Client” PC:

In addition, the diagnostics described above can be performed remotely using a simple Web browser thanks to the standard Web server integrated in the Modicon X80 I/O platform (processor with integrated Ethernet port or Ethernet module), using the “ready-to-use” Rack Viewer function.

- **Compatibility with 2-wire and 3-wire sensors:** The discrete input modules can be used in conjunction with OsiSense XS inductive proximity sensors (for compatibility, see [page 7/4](#)) and with OsiSense XU photoelectric sensors (for compatibility, see [page 7/2](#)).

(1) For further information, please consult our website at [www.schneider-electric.com](http://www.schneider-electric.com).  
 (2) EcoStruxure Control Expert software continues the Unity Pro range of software and corresponds to versions  $\geq 14$  of Unity Pro.

Run		Err		I/O		+32	
0	1	2	3	4	5	6	7
8	9	10	11	12	13	14	15
16	17	18	19	20	21	22	23
24	25	26	27	28	29	30	31

Display block for module BMXDDO6402K

### Complementary characteristics

The following characteristics complement those introduced in the selection guide on pages 3/2 to 3/7.

#### DC input modules BMXDDI16●●/1604T/3202K/6402K and BMXDAI1602

- Input impedance at nominal voltage: 6.4 to 19.2 k $\Omega$ , depending on model
- Reverse polarity: Protection for modules BMXDDI1602/1603/3202K
- Paralleling of inputs (1): Yes, for modules BMXDDI1602/1603
- Dielectric strength between groups of channels: 500 V  $\overline{\text{---}}$  for modules BMXDDI3202K/6402K
- Temperature derating for module BMXDDI1604T: No derating up to 40 °C/104 °F, a maximum of 25% of inputs at state 1 at 70 °C/158 °F

#### AC input modules BMXDAI16●●/08●●

- Input frequency: 47 to 63 Hz
- Current peak on activation at nominal voltage: 5 to 380 mA depending on model
- Input impedance at nominal voltage and F = 55 Hz: 6 to 28 k $\Omega$ , depending on model

#### Triac output module BMXDAO1605

- Current via common: 2.4 A
- Current for the 4 commons together: 4.8 A

#### Isolated triac output module BMXDAO1615

- Current per module: 10 A maximum continuous

#### DC transistor output modules BMXDDO16●●/3202K/6402K

- Dielectric strength between groups of channels: 500 V  $\overline{\text{---}}$  for modules BMXDDO3202K/6402K

#### Relay output modules BMXDRA08●●●/1605 and BMXDRC0805

- Protection against AC inductive overvoltage: Use an RC circuit or ZNO surge limiter appropriate to the voltage in parallel on each output.
- Protection against DC inductive overvoltage: Use a discharge diode on each output.

#### Mixed I/O relay module BMXDDM16025

- Input impedance at nominal voltage: 6.8 k $\Omega$
- Dielectric strength between groups of inputs: 500 V  $\overline{\text{---}}$

#### DC mixed I/O modules BMXDDM16022/3202K

- Input impedance at nominal voltage: 6.8 to 9.6 k $\Omega$ , depending on model
- Reverse polarity on the inputs: Protection
- Paralleling of outputs: Yes, for a maximum of 2 outputs for module BMXDDM16022 and a maximum of 3 outputs for module BMXDDM3202K

(1) This characteristic allows several inputs to be wired in parallel on the same module or on different modules for input redundancy.

3



BMXDDI160●●  
BMXDAI●●●●



BMXDDI3202K



BMXDDI6402K



BMXDDO16●2

BMXDRA0815/  
0805/1605



BMXDDO3202K



BMXDDO6402K

### References

#### Discrete input modules (1)

Type of current	Input voltage	Connection via (2)	IEC/EN 61131-2 conformity	No. of channels (common)	Reference	Weight kg/lb	
DC	24 V (positive logic)	Caged, screw, or spring-type 20-way removable terminal block	Type 3	16 isolated inputs (1 x 16)	BMXDDI1602	0.115/0.254	
		One 40-way connector	Type 3	32 isolated inputs (2 x 16)	BMXDDI3202K	0.110/0.243	
		Two 40-way connectors	Non-IEC	64 isolated inputs (4 x 16)	BMXDDI6402K	0.145/0.320	
DC	24 V (negative logic)	Caged, screw, or spring-type 20-way removable terminal block	Non-IEC	16 isolated inputs (1 x 16)	BMXDAI1602	0.115/0.254	
		48 V (positive logic)	Caged, screw, or spring-type 20-way removable terminal block	Type 1	16 isolated inputs (1 x 16)	BMXDDI1603	0.115/0.254
			125 V (positive logic)	Caged, screw, or spring-type 20-way removable terminal block	Type 1	16 isolated inputs (1 x 16)	BMXDDI1604T
AC	24 V	Caged, screw, or spring-type 20-way removable terminal block	Type 1	16 isolated inputs (1 x 16)	BMXDAI1602	0.115/0.254	
		48 V	Caged, screw, or spring-type 20-way removable terminal block	Type 3	16 isolated inputs (1 x 16)	BMXDAI1603	0.115/0.254
	100...120 V	Caged, screw, or spring-type 20-way removable terminal block	Type 3	16 isolated inputs (1 x 16)	BMXDAI1604	0.115/0.254	
		Caged or spring-type 40-way removable terminal block	Type 1	16 isolated inputs (1 x 16)	BMXDAI1614	0.150/0.331	
	200...240 V	Caged, screw, or spring-type 20-way removable terminal block	Type 2	8 isolated inputs (1 x 8)	BMXDAI0805	0.152/0.335	
		Caged or spring-type 40-way removable terminal block	Type 1	16 isolated inputs (1 x 16)	BMXDAI1615	0.156/0.344	
	100...120 V	Caged, screw, or spring-type 20-way removable terminal block	Type 3	8 isolated inputs (8 x 1)	BMXDAI0814	0.115/0.254	

#### Discrete output modules (1)

Type of current	Output voltage	Connection via (2)	IEC/EN 61131-2 conformity	No. of channels (common)	Reference	Weight kg/lb	
transistor	24 V/0.5 A (positive logic)	Caged, screw, or spring-type 20-way removable terminal block	Yes	16 protected outputs (1 x 16)	BMXDDO1602	0.120/0.265	
		Caged, screw, or spring-type 20-way removable terminal block	Yes	16 protected outputs (1 x 16)	BMXDDO1612	0.120/0.265	
	24 V/0.1 A (positive logic)	One 40-way connector	Yes	32 protected outputs (2 x 16)	BMXDDO3202K	0.110/0.243	
		Two 40-way connectors	Yes	64 protected outputs (4 x 16)	BMXDDO6402K	0.150/0.331	
triac	100...240 V	Caged, screw, or spring-type 20-way removable terminal block	Yes	16 outputs (4 x 4)	BMXDAO1605	0.140/0.309	
	24...240 V	Caged, screw, or spring-type 40-way removable terminal block	Yes	16 isolated outputs	BMXDAO1615	0.250/0.551	
relay	100...150 V DC/0.3 A	Caged, screw, or spring-type 20-way removable terminal block	Yes	8 non-protected outputs	BMXDRA0804T	0.178/0.392	
	24 V DC/2 A	24...240 V AC/2 A	Caged, screw, or spring-type 20-way removable terminal block	Yes	8 non-protected outputs (without common)	BMXDRA0805	0.145/0.320
			Caged, screw, or spring-type 20-way removable terminal block	Yes	8 normally open isolated relay outputs	BMXDRA0815	0.210/0.463
	24 V DC/2 A	24...240 V AC/2 A	Caged, screw, or spring-type 20-way removable terminal block	Yes	16 non-protected outputs (2 x 8)	BMXDRA1605	0.150/0.331
			Caged, screw, or spring-type 40-way removable terminal block	Yes	8 normally open/ normally closed isolated relay outputs	BMXDRC0805	0.189/0.417

(1) Typical consumption: See the power consumption table available on our website [www.schneider-electric.com](http://www.schneider-electric.com).  
 (2) 64-channel modules have 2 connectors and therefore require 2 connection cables.



BMXDDM1602 • BMXDDM3202K

## References (continued)

## Discrete mixed I/O modules (1)

Number of connection I/O		No. of input channels (common)	No. of output channels (common)	IEC/EN 61131-2 conformity	Reference	Weight kg/lb
16	Caged, screw, or spring-type 20-way removable terminal block	8 (positive logic) (1 x 8)	8, transistor 24 V $\overline{\text{---}}$ /0.5 A (1 x 8)	Inputs, type 3	<a href="#">BMXDDM16022</a>	0.115/ 0.254
			8, relay 24 V $\overline{\text{---}}$ or 24...240 V $\sim$ (1 x 8)	Inputs, type 3	<a href="#">BMXDDM16025</a>	0.135/ 0.298
32	One 40-way connector	16 (positive logic) (1 x 16)	16, transistor 24 V $\overline{\text{---}}$ /0.1 A (1 x 16)	Inputs, type 3	<a href="#">BMXDDM3202K</a>	0.110/ 0.243

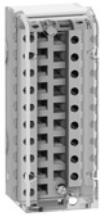

BMXFTB2000

## Removable terminal blocks

Description	For use with	Type	Reference	Weight kg/lb
20-way removable terminal blocks	For module with 20-way removable terminal block	Caged	<a href="#">BMXFTB2000</a>	0.093/ 0.205
		Screw clamp	<a href="#">BMXFTB2010</a>	0.075/ 0.165
		Spring	<a href="#">BMXFTB2020</a>	0.060/ 0.132
40-way removable terminal blocks	For standard version of module only with 40-way removable terminal block	Caged	<a href="#">BMXFTB4000</a>	0.166/ 0.366
		Spring	<a href="#">BMXFTB4020</a>	0.098/ 0.216

## Preassembled cordsets for 16-channel I/O modules with removable terminal block

Description	Composition	Cross-section	Length m/ft	Reference	Weight kg/lb
Preassembled cordsets with one end with flying leads for 16-channel I/O modules Operating voltage $\leq$ 48 V	One 20-way spring-type removable terminal block (BMXFTB2020) and one end with color-coded flying leads	0.324 mm <sup>2</sup> / AWG 22	3/9.84	<a href="#">BMXF3W301</a>	0.850/ 1.874
			5/16.4	<a href="#">BMXF3W501</a>	1.400/ 3.086
			10/32.8	<a href="#">BMXF3W1001</a>	2.780/ 6.129



BMXF3W01

## Preassembled cordsets for 16-, 32-, and 64-channel I/O modules with 40-way connectors

Description	No. of sheaths	Composition	Cross-section	Length m/ft	Reference	Weight kg/lb			
Preassembled cordsets with one end with flying leads	1 x 20 wires (16 channels)	One 40-way connector and one end with color-coded flying leads	0.324 mm <sup>2</sup> / AWG 22	3/9.84	<a href="#">BMXFCW301</a>	0.820/ 1.808			
				5/16.4	<a href="#">BMXFCW501</a>	1.370/ 3.020			
				10/32.8	<a href="#">BMXFCW1001</a>	2.770/ 6.107			
	2 x 20 wires (32 channels) (2)	One 40-way connector and two ends with color-coded flying leads	0.324 mm <sup>2</sup> / AWG 22	3/9.84	<a href="#">BMXFCW303</a>	0.900/ 1.984			
				5/16.4	<a href="#">BMXFCW503</a>	1.490/ 3.285			
				10/32.8	<a href="#">BMXFCW1003</a>	2.960/ 6.526			
Preassembled cordsets for Modicon Telefast ABE7 sub-bases	1 x 20 wires (16 channels)	One 40-way connector and one HE 10 connector	0.324 mm <sup>2</sup> / AWG 22	0.5/1.64	<a href="#">BMXFCC051</a>	0.140/ 0.309			
				1/3.28	<a href="#">BMXFCC101</a>	0.195/ 0.430			
				2/6.56	<a href="#">BMXFCC201</a>	0.560/ 1.235			
				3/9.84	<a href="#">BMXFCC301</a>	0.840/ 1.852			
				5/16.4	<a href="#">BMXFCC501</a>	1.390/ 3.064			
				10/32.8	<a href="#">BMXFCC1001</a>	2.780/ 6.123			
				2 x 20 wires (32 channels) (2)	One 40-way connector and two HE 10 connectors	0.324 mm <sup>2</sup> / AWG 22	0.5/1.64	<a href="#">BMXFCC053</a>	0.210/ 0.463
				1/3.28			<a href="#">BMXFCC103</a>	0.350/ 0.772	
				2/6.56			<a href="#">BMXFCC203</a>	0.630/ 1.389	
3/9.84	BMXFCC303	0.940/ 2.072	5/16.4	<a href="#">BMXFCC503</a>	1.530/ 3.373				
			10/32.8	<a href="#">BMXFCC1003</a>	3.000/ 6.614				



BMXFCW01



BMXFCW03



BMXFCC01

(1) Typical consumption: See the power consumption table available on our website [www.schneider-electric.com](http://www.schneider-electric.com).

(2) 64-channel modules have 2 connectors and therefore require 2 connection cables.

# Modicon X80 modules platform

## Analog I/O modules Input modules

### Applications

### Analog inputs



<b>Type of input</b>		Isolated low-level inputs, voltage, thermocouples, temperature probes, resistors	
<b>Type</b>		Multirange	
<b>Range</b>	Voltage	± 40 mV, ± 80 mV, ± 160 mV, ± 320 mV, ± 640 mV, ± 1.28 V	
	Current	–	
	Thermocouple Temperature probe	Thermocouples, type B, E, J, K, L, N, R, S, T, U 2-, 3- or 4-wire temperature probes, type Pt100, JPt100, Pt1000, JPt1000, Ni100, Ni1000 (in accordance with DIN43760), and Cu 10	
	Resistor	2-, 3- or 4-wire resistors, 400 Ω or 4000 Ω	
<b>Modularity</b>		4 inputs	8 inputs
<b>Acquisition period</b>		400 ms for the 4 inputs	400 ms for the 8 inputs
<b>Conversion time</b>		–	
<b>Resolution</b>		15 bits + sign	
<b>Isolation</b>	Between channels	750 V $\overline{\text{---}}$	
	Between channels and bus	1400 V $\overline{\text{---}}$	
	Between channels and ground	750 V $\overline{\text{---}}$	
<b>Connection</b>	Directly to the module	Via 40-way connector	Via two 40-way connectors
	Via preassembled cordsets	Cordsets with one end with color-coded flying leads BMXFCW●01S (3 or 5 m/9.84 or 16.4 ft)	
<b>Compatibility with Modicon Telefast ABE7 pre-wired system (1)</b>	Connection sub-base	4-channel sub-base for direct connection of 4 thermocouples plus connection and provision of cold junction compensation	
	Type of connection sub-base	ABE7CPA412	
	Type of preassembled cordsets	BMXFCA●●2 (1.5, 3, or 5 m/4.92, 9.84, or 16.4 ft)	

### References

**BMXART0414** | **BMXART0814**

### Pages

3/22

(1) For more information, please refer to the "Telefast Pre-wired system – Modicon ABE7 IP20 connection sub-bases" catalog or visit our website [www.schneider-electric.com](http://www.schneider-electric.com).

### Analog inputs



Isolated high-level inputs	Non-isolated high-level inputs	Isolated high-level inputs
<b>Voltage/current</b>		
± 10 V, 0...10 V, 0...5 V, 1..5 V, ± 5 V		
0...20 mA, 4...20 mA, ± 20 mA		
–		
4 inputs	8 inputs	
Fast: 1 + (1 x no. of declared channels) ms Default: 5 ms for the 4 channels	Fast: 1 + (1 x no. of declared channels) ms Default: 9 ms for the 8 channels	
–		
16 bits	15 bits + sign	
300 V $\overline{\text{---}}$	–	300 V $\overline{\text{---}}$
1400 V $\overline{\text{---}}$		
1400 V $\overline{\text{---}}$		
Via 20-way removable terminal block (caged, screw, or spring-type) BMXFTB20●0	Via 28-way removable terminal block (caged) BMXFTB2800 or (spring) BMXFTB2820	
Cordsets with one end with color-coded flying leads BMXFTW●01S (3 or 5 m/9.84 or 16.4 ft)	Cordsets with one end with color-coded flying leads BMXFTW●08S (3 or 5 m/9.84 or 16.4 ft)	
4-channel sub-base for direct connection of 4 inputs, delivers and distributes 4 protected isolated power supplies	8-channel sub-base for direct connection of 8 current/voltage inputs	
ABE7CPA410	ABE7CPA02/03/31/31E	ABE7CPA02/31/31E
BMXFCA●●0 (1.5, 3, or 5 m/4.92, 9.84, or 16.4 ft)	BMXFTA●●0 (1.5 or 3 m/4.92 or 9.84 ft)	

**BMXAMI0410** | **BMXAMI0800** | **BMXAMI0810**

3/22

# Modicon X80 modules platform

Analog I/O modules  
Output modules and mixed I/O modules

## Applications

## Analog outputs



Type of I/O	
Type	
Range	Voltage
	Current
Modularity	
Acquisition period (inputs)	
Conversion time (outputs)	
Resolution	Inputs
	Outputs
Isolation	
Connection	Directly to the module
	Via preassembled cordsets
Compatibility with Modicon Telefast ABE7 pre-wired system (1)	Connection sub-base
	Type of connection sub-base
	Type of preassembled cordsets

Isolated high-level outputs	Isolated high-level outputs	Non-isolated high-level outputs
Voltage/current		Current
± 10 V		–
0–20 mA, 4–20 mA		
2 outputs	4 outputs	8 outputs
–		
≤ 1 ms		≤ 4 ms
–		–
15 bits + sign		–
Between channels: 750 V ---		
Between channels and bus: 1400 V ---		
Between channels and ground: 1400 V ---		
Via 20-way removable terminal block (screw or spring-type) BMXFTB20●0		
Cordsets with one end with color-coded flying leads BMXFTW●01S (3 or 5 m/9.84 or 16.4 ft)		
4-channel sub-base for direct connection of 2/4 current/voltage outputs		8-channel sub-base for direct connection of 8 current/voltage inputs
ABE7CPA21		ABE7CPA02
BMXFCA●●0 (1.5, 3, or 5 m/4.92, 9.84, or 16.4 ft)		BMXFTA●●2 (1.5 or 3 m/4.92 or 9.84 ft)

## References

<b>BMXAMO0210</b>	<b>BMXAMO0410</b>	<b>BMXAMO0802</b>
-------------------	-------------------	-------------------

## Pages

3/22

(1) For more information, please refer to the "Telefast Pre-wired system – Modicon ABE7 IP20 connection sub-bases" catalog or visit our website [www.schneider-electric.com](http://www.schneider-electric.com).

## Mixed analog I/O



Non-isolated high-level inputs and outputs	
Voltage/current	
Inputs: ± 10 V, 0...10 V, 0...5 V, 1..5 V Outputs: ± 10 V	
Inputs: 0–20 mA, 4–20 mA Outputs: 0–20 mA, 4–20 mA	
4 inputs and 2 outputs	
Fast: 1 + (1 x no. of declared channels) ms Default: 5 ms for the 4 channels	
≤ 1 ms	
14...12-bit in U range 12-bit in I range	
12-bit in U range 11-bit in I range	
Between groups of input or output channels: 750 V ---	
Between channels and bus: 1400 V ---	
Between channels and ground: 1400 V ---	
Via 20-way removable terminal block (screw or spring-type) BMXFTB20●0	
BMXFTW●01S cordsets with one end with color-coded flying leads (3 or 5 m/9.84 or 16.4 ft)	
–	
–	
–	

## BMXAMM0600

3/22

### Presentation

The Modicon X80 I/O analog module offer comprises:

- 5 analog input modules:
  - 2 modules with 4 and 8 isolated channels, low-level voltage, thermocouples, Pt, JPt, Ni, or Cu temperature probes and resistors, 15 bits + sign **BMXART0414/0814**
  - 1 module with 4 high-speed isolated analog channels, high-level voltage or current, 16 bits **BMXAMI0410**
  - 2 modules with 8 high-speed non-isolated analog channels, high-level voltage or current, 15 bits + sign **BMXAMI0800/0810**
- 3 analog output modules:
  - 1 module with 2 isolated analog channels, high-level voltage or current, 15 bits + sign **BMXAMO0210**
  - 1 module with 4 isolated analog channels, high-level voltage or current, 15 bits + sign **BMXAMO0410**
  - 1 module with 8 non-isolated analog channels, high-level current, 15 bits + sign **BMXAMO0802**
- 1 mixed analog I/O module with 4 input channels and 2 output channels (non-isolated), voltage or current, 12 to 14 bits according to type of channel and range **BMXAMM0600**

Analog I/O modules are equipped with a connector for a 20 or 28-way removable terminal block, except for **BMXART0414/0814** analog input modules for thermocouples/temperature probes, which are equipped with one or two 40-way connector(s).

All analog modules occupy a single slot in **BMEXBP●●●** or **BMXXBP●●●** racks. These modules can be installed in any slot in the rack, except the first two (PS and 00), which are reserved for the power supply module and the processor module respectively.

The power supply for the analog functions is supplied by the backplane bus (3.3 V and 24 V). Analog I/O modules are hot-swappable (see [page 3/10](#)).



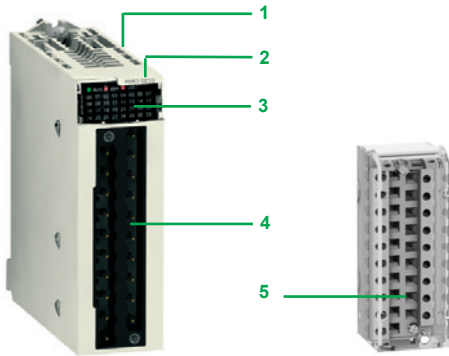

Module for connection via 20 or 28-way removable terminal block

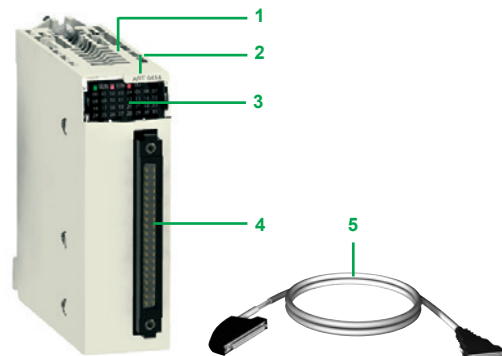

Module for connection via 40-way connector

### Description

**BMXAM●/ART** analog I/O modules are standard format (1 slot). They have a case, which provides IP20 protection of the electronics, and are locked into position by a captive screw.

#### I/O modules connected via 20 or 28-way removable terminal block

**BMXAM●** analog I/O modules feature the following:

- 1 A rigid body providing support and protection for the electronic card
- 2 A module reference marking (a label is also visible on the right-hand side of the module)
- 3 A module and channel status display block
- 4 A connector taking the 20 or 28-way removable screw or spring-type terminal block for directly connecting the sensors or preactuators to the module

**To be ordered separately:**

- 5 **BMXFTB20●0** or **BMXFTB28●0** 20 or 28-way removable terminal block (referencing label supplied with each I/O module) or pre-wired cables with:
  - A 20-way terminal block at one end and flying leads at the other (**BMXFTW●01S**)
  - A 28-way terminal block at one end and flying leads at the other (**BMXFTW●08S**)
  - A 20 or 28-way terminal block and a 25-way SUB-D connector (**BMXFCA●●0** or **BMXFCA●●2**), for connection to Modicon Telefast ABE7 sub-bases (see [page 3/23](#))

#### I/O modules connected via 40-way connector

**BMXART** analog input modules have the following on the front panel:

- 1 A rigid body providing support and protection for the electronic card
- 2 A module reference marking (a label is also visible on the right-hand side of the module)
- 3 A module and channel status display block
- 4 One (or two) 40-way connector(s) for connecting the sensors

**To be ordered separately:**

- 5 Pre-wired cables with:
  - A 40-way connector at one end and flying leads at the other (**BMXFCW●01S**)
  - A 40-way connector and a 25-way SUB-D connector (**BMXFCA●●2**) for direct connection to Modicon Telefast ABE7 sub-bases (see [page 3/23](#))

**To be ordered separately:**

- A shielding connection kit to help protect against electrostatic discharge, consisting of a metal bar and two sub-bases for mounting on the rack supporting the analog modules
- A set of **STBXSP3020** clamping rings for the shielding braids of analog signal cables

3

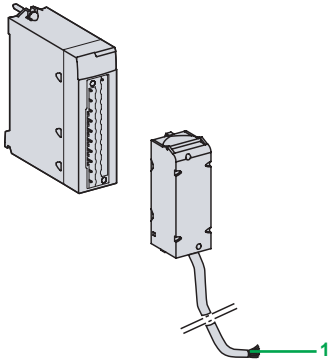

**BMXFTW01S cordset**  
(with 20-way removable terminal block at one end and flying leads at the other)

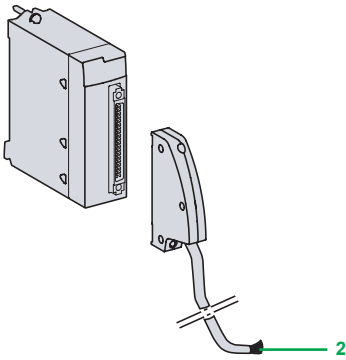

**BMXFCW01S cordset**  
(with 40-way connector at one end and flying leads at the other)

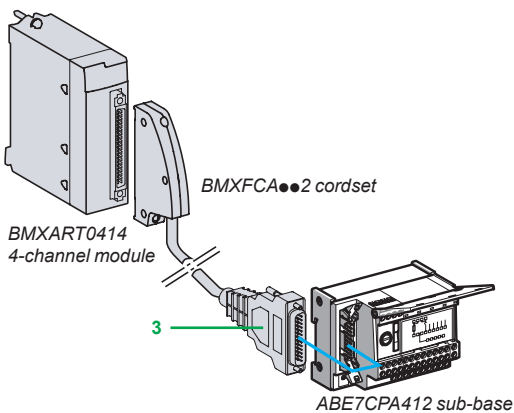

**BMXART0414**  
4-channel module

**BMXFCA002 cordset**

**ABE7CPA412 sub-base**

### Connecting modules with removable terminal blocks

#### BMXAMI0410, BMXAMO, and BMXAMM modules with 20-way terminal block

The 20-way removable terminal blocks (**BMXFTB2000**) are the same as those used for discrete I/O modules (screw clamp, caged, or spring-type) (see [page 3/9](#)). One version of the removable terminal block is equipped with a 3 or 5 m/9.84 or 16.4 ft cordset with color-coded flying leads (**BMXFTW01S**). These preassembled cordsets with reinforced shielding have color-coded flying leads at the other end **1**.

#### BMXAMI0800/0810 modules with 28-way terminal block

The 28-way removable terminal blocks are caged (**BMXFTB2800**) or spring-type (**BMXFTB2820**). One version of the removable terminal block is equipped with a 3 or 5 m/9.84 or 16.4 ft cordset with color-coded flying leads (**BMXFTW08S**). These preassembled cordsets with reinforced shielding have color-coded flying leads at the other end **1**.

### Connecting modules with 40-way connectors

#### BMXART014 modules with 40-way connectors

Two types of cordset are available:

- Preassembled cordsets with reinforced shielding (**BMXFCW01S**) which have color-coded flying leads at the other end **2**. Available in 3 or 5 m/9.84 or 16.4 ft lengths, they enable easy direct wire-to-wire connection of the analog sensors via terminal blocks.
- Preassembled cordsets with reinforced shielding (**BMXFCA002**) which have a 25-way SUB-D connector at the other end **3**. Available in 1.5, 3, or 5 m/4.92, 9.84, or 16.4 ft lengths, they enable direct connection to the Modicon Telefast **ABE7CPA412** sub-base (see below).

### Use with Modicon Telefast ABE7 sub-bases

Using the Modicon Telefast **ABE7** pre-wired system makes it easier to install the modules since the inputs (or outputs) can be accessed via screw terminals. Seven special sub-bases are available:

#### Modicon Telefast ABE7CPA410 sub-base

The Modicon Telefast **ABE7CPA410** sub-base is mainly used in conjunction with the **BMXAMI0410** voltage/current analog 4-input module. This sub-base allows you to:

- Directly connect 4 sensors
- Remotely locate the input terminals in voltage mode
- Power the 4 to 20 mA conditioning units one channel at a time with a 24 V voltage, protected and limited to 25 mA, while maintaining isolation between channels
- Help protect the current impedance matching resistors integrated in the sub-base against overvoltages

Connection is via the **BMXFCA000** cordset (1.5, 3, or 5 m/4.92, 9.84, or 16.4 ft).

#### Modicon Telefast ABE7CPA412 sub-base

The Modicon Telefast **ABE7CPA412** sub-base is specially designed as a wiring interface for the **BMXART0414** and **BMXART0814** thermocouple modules. This sub-base allows you to:

- Connect 4 thermocouple probes
- Provide external cold junction compensation with a temperature probe integrated in the sub-base
- Provide continuity of the shielding

The **BMXART0814** module requires two Modicon Telefast **ABE7CPA412** sub-bases. The connection with each sub-base is made via a **BMXFCA002** cordset (1.5, 3, or 5 m/4.92, 9.84, or 16.4 ft).

#### Modicon Telefast ABE7CPA21 sub-base

The Modicon Telefast **ABE7CPA21** sub-base is compatible with the **BMXAMO0210** output module. This sub-base allows you to:

- Directly connect 2 current/voltage outputs
- Provide continuity of the shielding

Connection is via the **BMXFCA000** cordset **3** (1.5, 3, or 5 m/4.92, 9.84, or 16.4 ft).

### Use with Modicon Telefast ABE7 sub-bases (continued)

#### Modicon Telefast ABE7CPA02 sub-base

The Modicon Telefast **ABE7CPA02** sub-base can be used in combination with:

- **BMXAMI0800/0810** analog current input modules with 8 inputs
- **BMXAMO0802** analog current output modules with 8 outputs

This sub-base allows you to:

- Connect the 8 analog inputs or outputs point-to-point
- Provide continuity of the shielding

**BMXAMI0800/0810** modules are connected via 1.5 or 3 m/4.92 or 9.84 ft

**BMXFTA●●0** cables.

The **BMXAMO0802** module is connected via 1.5, 3, or 5 m/4.92, 9.84, or 16.4 ft

**BMXFTA●●2** cables.

#### Modicon Telefast ABE7CPA03 sub-base

The Modicon Telefast **ABE7CPA03** sub-base can be used in combination with the **BMXAMI0800** voltage/current analog 8-input module.

This sub-base allows you to:

- Directly connect 8 analog inputs
- Power the current inputs one channel at a time with a voltage of 24 V that is protected and limited to 25 mA
- Provide continuity of the shielding

The **BMXAMI0800** module is connected via 1.5 or 3 m/4.92 or 9.84 ft **BMXFTA●●0** cables.

#### Modicon Telefast ABE7CPA31/31E sub-bases

The Modicon Telefast **ABE7CPA31/31E** sub-bases can be used in combination with the **BMXAMI0800/0810** voltage/current analog 8-input modules.

These sub-bases allow you to:

- Directly connect 8 analog inputs
- Power the current inputs one channel at a time with 24 V converters
- Provide continuity of the shielding

**BMXAMI0800/0810** modules are connected via 1.5 or 3 m/4.92 or 9.84 ft

**BMXFTA●●0** cables.

### Complementary characteristics

#### BMXART0414/0814 analog input modules

**BMXART0414/0814** modules are multirange input modules with 4 or 8 low-level isolated inputs (15 bits + sign) respectively.

Depending on the choice made during configuration, the modules offer, for each of the inputs, the following ranges:

- Temperature probe: Pt100, JPt100, Pt1000, JPt1000, Cu10, Ni100, or Ni1000 (in accordance with DIN43760), with open-circuit detection
- Thermocouple: B, E, J, K, L, N, R, S, T, or U with broken wire detection
- Resistor: 0...400 or 0...4000  $\Omega$ , 2-, 3-, or 4-wire
- Voltage:  $\pm 40$  mV,  $\pm 80$  mV,  $\pm 160$  mV,  $\pm 320$  mV,  $\pm 640$  mV,  $\pm 1.28$  V

#### BMXAMI0410 analog input module

The **BMXAMI0410** module is a high-level analog input module with 4 isolated inputs (16 bits).

Used with sensors or transmitters, it performs monitoring, measurement, and process control functions for continuous processes.

The module offers the following ranges for each of the inputs depending on the choice made during configuration:

- Voltage  $\pm 10$  V,  $\pm 5$  V, 0...10 V, 0...5 V, and 1...5 V
- Current 0–20 mA, 4–20 mA, and  $\pm 20$  mA

#### BMXAMI0800/0810 analog input modules

**BMXAMI0800/0810** analog input modules have 8 high-level isolated/non-isolated analog inputs (15 bits + sign).

The modules offer the following ranges for each of the inputs depending on the choice made during configuration:

- Voltage:  $\pm 10$  V, 0...10 V, 0...5 V, 1...5 V,  $\pm 5$  V
- Current: 0–20 mA and 4–20 mA

### Complementary characteristics (continued)

#### BMXAMO0210 analog output module

The **BMXAMO0210** module has 2 high-level isolated outputs (15 bits + sign).  
The **BMXAMO0210** module offers the following ranges for each of the inputs depending on the choice made during configuration:

- Voltage:  $\pm 10$  V
- Current: 0–20 mA and 4–20 mA

#### BMXAMO0410/0802 analog output modules

**BMXAMO0410/0802** analog output modules have 4 or 8 high-level isolated/non-isolated analog outputs (16 bits/15 bits + sign).

The **BMXAMO0410** module offers the following ranges for each of the outputs depending on the choice made during configuration:

- Voltage:  $\pm 10$  V
- Current: 0–20 mA and 4–20 mA

The **BMXAMO0802** module offers the current ranges 0–20 mA and 4–20 mA.

#### BMXAMM0600 analog mixed I/O module

The **BMXAMM0600** mixed module is a non-isolated I/O module with 4 inputs (14/12 bits) and 2 outputs (12 bits). The module offers the following ranges for each of the inputs or outputs depending on the choice made during configuration:

- Voltage:  $\pm 10$  V, 0...10 V, 0...5 V, and 1...5 V
- Current: 0–20 mA and 4–20 mA

### References

#### Analog input modules (1)

Type of input	Input signal range	Resolution	Connection via	No. of channels	Reference	Weight kg/lb
Isolated high-level inputs	$\pm 10$ V, 0...10 V, 0...5 V, 1...5 V, $\pm 5$ V, 0–20 mA, 4–20 mA, $\pm 20$ mA	16 bits	Caged, screw clamp, or spring-type 20-way removable terminal block	4 channels	<a href="#">BMXAMI0410</a>	0.143/ 0.315
Non-isolated high-level inputs	$\pm 10$ V, 0...10 V, 0...5 V, 1...5 V, $\pm 5$ V, 0–20 mA	15 bits + sign	Caged or spring-type 28-way removable terminal block	8 channels	<a href="#">BMXAMI0800</a>	0.175/ 0.386
Isolated high-level inputs	$\pm 10$ V, 0...10 V, 0...5 V, 1...5 V, $\pm 5$ V, 0–20 mA	15 bits + sign	Caged or spring-type 28-way removable terminal block	8 channels	<a href="#">BMXAMI0810</a>	0.175/ 0.386
Isolated low-level inputs	Temperature probe, thermocouple, $\pm 40$ mV, $\pm 80$ mV, $\pm 160$ mV, $\pm 320$ mV, $\pm 640$ mV, $\pm 1.28$ V	15 bits + sign	40-way connector	4 channels	<a href="#">BMXART0414</a>	0.135/ 0.298
				8 channels	<a href="#">BMXART0814</a>	0.165/ 0.364



BMXAMO0210



BMXART0414

#### Analog output modules (1)

Type of outputs	Output signal range	Resolution	Connection via	No. of channels	Reference	Weight kg/lb
Isolated high-level outputs	$\pm 10$ V, 0–20 mA, 4–20 mA	16 bits	Caged, screw clamp, or spring-type 20-way removable terminal block	2 channels	<a href="#">BMXAMO0210</a>	0.144/ 0.317
High-level outputs isolated	$\pm 10$ V, 0–20 mA, 4–20 mA, $\pm 20$ mA	15 bits + sign	Caged, screw clamp, or spring-type 20-way removable terminal block	4 channels	<a href="#">BMXAMO0410</a>	0.175/ 0.386
Non-isolated high-level inputs	0–20 mA, 4–20 mA	15 bits + sign	Caged, screw clamp, or spring-type 20-way removable terminal block	8 channels	<a href="#">BMXAMO0802</a>	0.175/ 0.386

#### Analog mixed I/O module (1)

Type of I/O	Signal range	Resolution	Connection via	No. of channels	Reference	Weight kg/lb
Mixed I/O, non-isolated	$\pm 10$ V, 0...10 V, 0...5 V, 1...5 V, 0–20 mA, 4–20 mA	14 bits or 12 bits depending on the range	Caged, screw clamp, or spring-type 20-way removable terminal block	Inputs: 4 channels Outputs: 2 channels	<a href="#">BMXAMM0600</a>	0.155/ 0.342

(1) Typical consumption: See the power consumption table available on our website [www.schneider-electric.com](http://www.schneider-electric.com).

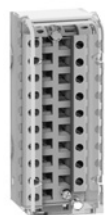

BMXFTB2000



BMXFTW01S



ABE7CPA41/21



BMXFCA000



BMXFCA002

## References (continued)

## Connection accessories for analog modules (1)

Description	For use with modules	Type, composition	Length	Reference	Weight kg/lb
20-way removable terminal blocks	BMXAMI0410 BMXAMO0210 BMXAMO0410 BMXAMO0802 BMXAMM0600	Caged	–	<a href="#">BMXFTB2000</a>	0.093/ 0.205
		Screw clamp	–	<a href="#">BMXFTB2010</a>	0.075/ 0.165
		Spring	–	<a href="#">BMXFTB2020</a>	0.060/ 0.132
28-way removable terminal blocks	BMXAMI0800 BMXAMI0810	Caged	–	<a href="#">BMXFTB2800</a>	0.111/ 0.245
		Spring	–	<a href="#">BMXFTB2820</a>	0.080/ 0.176
Preassembled cordsets	BMXAMI0410 BMXAMO0210 BMXAMO0410 BMXAMO0802 BMXAMM0600	One 20-way terminal block (BMXFTB2020) and one end with color-coded flying leads	3 m/9.84 ft	<a href="#">BMXFTW301S</a>	0.470/ 1.036
	5 m/16.4 ft		<a href="#">BMXFTW501S</a>	0.700/ 1.543	
	BMXAMI0800 BMXAMI0810	One 28-way removable terminal block, MX FTB 2820, and one end with color-coded flying leads	3 m/9.84 ft	<a href="#">BMXFTW308S</a>	0.435/ 0.959
	5 m/16.4 ft		<a href="#">BMXFTW508S</a>	0.750/ 1.653	
	BMXART0414 BMXART0814	One 40-way connector and one end with color-coded flying leads	3 m/9.84 ft	<a href="#">BMXFCW301S</a>	0.480/ 1.058
	5 m/16.4 ft		<a href="#">BMXFCW501S</a>	0.710/ 1.565	

## Modicon Telefast ABE7 pre-wired system

Description	For use with modules	Type, composition	Length or connection technology	Reference	Weight kg/lb
Modicon Telefast ABE7 sub-bases	BMXAMI0410	Distribution of isolated power supplies. Delivers 4 protected isolated power supplies for 4–20 mA inputs. Direct connection of 4 inputs	Screws	<a href="#">ABE7CPA410</a>	0.180/ 0.397
	BMXART0414 BMXART0814 (2)	Connection and provision of cold-junction compensation for thermocouples Direct connection of 4 inputs	Screws	<a href="#">ABE7CPA412</a>	0.180/ 0.397
	BMXAMO0210 BMXAMO0410	Direct connection of 2/4 outputs	Screws	<a href="#">ABE7CPA21</a>	0.210/ 0.463
	BMXAMI0800 BMXAMI0810 BMXAMO0802	Point-to-point connection of 8 I/O	Screws	<a href="#">ABE7CPA02</a>	0.317/ 0.699
	BMXAMI0800	Direct connection of 8 inputs. Delivers 8x 24 V $\pm$ power supplies limited to 25 mA to the 8 current inputs	Screws	<a href="#">ABE7CPA03</a>	0.307/ 0.677
	BMXAMI0800 BMXAMI0810	Direct connection of 8 inputs Delivers 8x 24 V $\pm$ power supplies isolated and limited to 25 mA to the 8 current inputs	Screws	<a href="#">ABE7CPA31</a>	0.498/ 1.098
			Spring	<a href="#">ABE7CPA31E</a>	0.508/ 1.120
Preassembled cordsets for Modicon Telefast ABE7 sub-bases	BMXAMI0410 BMXAMO0210 BMXAMO0410	One 20-way removable terminal block and one 25-way SUB-D connector for ABE7CPA410/CPA21 sub-base	1.5 m/4.92 ft	<a href="#">BMXFCA150</a>	0.320/ 0.705
			3 m/9.84 ft	<a href="#">BMXFCA300</a>	0.500/ 1.102
			5 m/16.4 ft	<a href="#">BMXFCA500</a>	0.730/ 1.609
	BMXART0414 BMXART0814 (2)	One 40-way connector and one 25-way SUB-D connector for ABE7CPA412 sub-base	1.5 m/4.92 ft	<a href="#">BMXFCA152</a>	0.330/ 0.728
			3 m/9.84 ft	<a href="#">BMXFCA302</a>	0.510/ 1.124
			5 m/16.4 ft	<a href="#">BMXFCA502</a>	0.740/ 1.631
	BMXAMI0800 BMXAMI0810	One 28-way removable terminal block and one 25-way SUB-D connector for sub-bases ABE7CPA02/03/31/31E	1.5 m/4.92 ft	<a href="#">BMXFCA150</a>	0.374/ 0.825
			3 m/9.84 ft	<a href="#">BMXFCA300</a>	0.500/ 1.102
	BMXAMO0802	One 20-way removable terminal block and one 25-way SUB-D connector for ABE7CPA02 sub-bases	1.5 m/4.92 ft	<a href="#">BMXFCA152</a>	0.374/ 0.825
			3 m/9.84 ft	<a href="#">BMXFCA302</a>	0.500/ 1.102

(1) The shielding on the cordsets carrying the analog signals must always be connected to the [BMXXSP000](#) shielding connection kit mounted under the rack holding the analog modules (see [page 2/3](#)).

(2) The [BMXART0814](#) 8-channel module requires two [ABE7CPA412](#) sub-bases and two [BMXFCA002](#) cordsets.

Applications

HART analog inputs



<b>Type of I/O</b>		Isolated analog inputs with HART
<b>Number of channels</b>		8
<b>Range</b>	Current	4-20 mA
<b>Maximum load impedance</b>		—
<b>Operating temperature</b>		0...60°C/32...140°F
<b>Compatible devices</b>		BMEP58●●●● processors, BMECRA31210 drop module, BMEXBP●●●00(H) Ethernet + X-bus backplanes, 140NOC78000 Quantum Ethernet DIO module
<b>Resolution</b>		15 bits + sign
<b>Isolation</b>	Between channels	1000 V ~ for 1 minute
	Between channels and bus	1400 V ~ for 1 minute
	Between channels and ground	1400 V ~ for 1 minute
<b>Connection</b>	Directly to the module	Via 20-way removable terminal blocks (screw or spring-type) BMXFTB20●0
<b>Compatibility with pre-wired ABE7</b>	Connection sub-base	8-channel sub-base for direct connection of 8 current/voltage inputs
	Type of connection sub-base	ABE7CPA02/03/31
	Type of preassembled cordsets	BMXFCA1522/3022 (1.5 or 3 m/4.92 or 9.84 ft)
<b>Field device support</b>		2-wire/4-wire
<b>HART specification</b>	HART field device compliance	HART V5, V6, V7
	HART field device connection	Point-to-point
	HART I/O mapping	Yes

References

**BMEAHI0812**

Page

3/27

HART analog outputs



<b>Type of I/O</b>		Isolated analog outputs with HART
<b>Number of channels</b>		4
<b>Range</b>		4-20 mA
<b>Maximum load impedance</b>		600 Ω (0-20 mA)
<b>Operating temperature</b>		0...60°C/32...140°F
<b>Compatible devices</b>		BMEP58●●●● processors, BMECRA31210 drop module, BMEXBP●●●00(H) Ethernet + X-bus backplanes, 140NOC78000 Quantum Ethernet DIO module
<b>Resolution</b>		15 bits + sign
<b>Isolation</b>	Between channels	1000 V ~ for 1 minute
	Between channels and bus	1400 V ~ for 1 minute
	Between channels and ground	1400 V ~ for 1 minute
<b>Connection</b>	Directly to the module	Via 20-way removable terminal blocks (screw or spring-type) BMXFTB20●0
<b>Compatibility with pre-wired ABE7</b>	Connection sub-base	4-channel sub-base for direct connection of 2/4 current/voltage outputs
	Type of connection sub-base	ABE7CPA21
	Type of preassembled cordsets	BMXFCA150/300/500 (1.5, 3, or 5 m/4.92, 9.84, or 16.4 ft)
<b>Field device support</b>		2-wire/4-wire
<b>HART specification</b>	HART field device compliance	HART V5, V6, V7
	HART field device connection	Point-to-point
	HART I/O mapping	Yes

**BMEAHO0412**

3/27

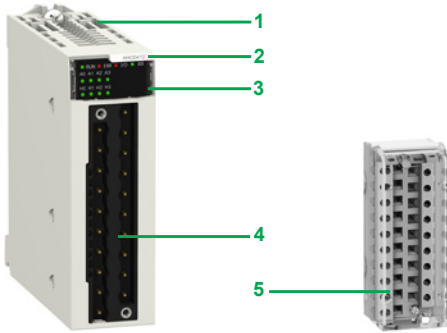

Module for connection via 20-way removable terminal block

3

### Presentation

**BMEAH●0●12** HART analog I/O modules contain transceivers that control HART devices and information through the module. They can be managed by the AMS (Asset Management System) or by the automation platform CPU.

These modules require an Ethernet + X-bus backplane and can only be installed in the main local rack with the CPU or in RIO drops with a **BMECRA31210** performance EIO adapter module. They cannot be installed in expansion racks.

### Description

**BMEAH●0●12** HART analog I/O modules are standard format (1 slot). They have a case, which provides IP20 protection of the electronics, and are locked into position by a captive screw. They are connected via a 20-way removable terminal block.

**BMEAH●0●12** HART analog I/O modules feature the following:

- 1 A rigid body providing support and protection for the electronic card
- 2 A module reference marking (a label is also visible on the right-hand side of the module)
- 3 A module and channel status display block
- 4 A connector taking the 20-way removable screw or spring-type terminal block for directly connecting the sensors or preactuators to the module

To be ordered separately:

- 5 A **BMXFTB20●0** 20-way removable terminal block (referencing label supplied with each I/O module) or pre-wired cables with:
  - A 20-way terminal block at one end and flying leads at the other (**BMXFTW●01S**)
  - A 20-way terminal block and a 25-way SUB-D connector (**BMXFCA●●0** or **BMXFTA●●22**), for connection to Modicon Telefast ABE 7 sub-bases

### Connecting modules using 20-way removable terminal blocks

The 20-way removable terminal blocks (**BMXFTB20●0**) are the same as those used for discrete I/O modules (screw clamp, caged or spring-type) (see [page 3/13](#)).

One version of the removable terminal block is equipped with a 3 or 5 m/9.84 or 16.4 ft cordset with color-coded flying leads (**BMXFTW●01S**). These preassembled cordsets with reinforced shielding have color-coded flying leads at the other end.



**BMXFTW●01S**



**BMXFCA●●0**

### Use with Modicon Telefast ABE7 sub-bases

#### Modicon Telefast ABE7CPA21 sub-base

The Modicon Telefast **ABE7CPA21** sub-base is compatible with the **BMEAH00412** output module.

This sub-base allows you to:

- Directly connect two current/voltage outputs
- Ensure continuity of the shielding

Connection is via the **BMXFCA●●0** cordset (1.5, 3, or 5 m/4.92, 9.84, or 16.4 ft long).

#### Modicon Telefast ABE7CPA02 sub-base

The Modicon Telefast **ABE7CPA02** sub-base can be used with the **BMEAH10812** HART analog input module.

This sub-base allows you to:

- Connect the 8 analog inputs point-to-point
- Ensure continuity of the shielding

The **BMEAH10812** module is connected by means of the 1.5 or 3 m/4.92 or 9.84 ft long **BMXFTA1522/3022** cables.

### Use with Modicon Telefast ABE7 sub-bases

#### Modicon Telefast ABE7CPA03 sub-base

The Modicon Telefast **ABE7CPA03** sub-base can be used with the **BMEAHI0812** HART analog input module.

This sub-base allows you to:

- Directly connect the 8 analog inputs
- Power the current inputs one channel at a time with a voltage of 24 V that is protected and limited to 25 mA
- Ensure continuity of the shielding

The **BMEAHI0812** module is connected by means of the 1.5 or 3 m/4.92 or 9.84 ft long **BMXFTA1522/3022** cables (1).

#### Modicon Telefast ABE7CPA31 sub-base

The Modicon Telefast **ABE7CPA31** sub-base can be used with the **BMEAHI0812** HART analog input module.

This sub-base allows you to:

- Directly connect the 8 analog inputs
- Power the current inputs one channel at a time with 24 V converters
- Ensure continuity of the shielding

The **BMEAHI0812** module is connected by means of the 1.5 or 3 m/4.92 or 9.84 ft long **BMXFTA1522/3022** cables.

### Additional characteristics

#### BMEAHI0812 HART analog input module

The **BMEAHI0812** module is a module with 8 high-level isolated inputs (15 bits + sign).

The **BMEAHI0812** module offers the current range 4 - 20 mA for each of the inputs depending on the choice made during configuration.

#### BMEAHO0412 HART analog output module

The **BMEAHO0412** module is a module with 4 high-level isolated outputs (15 bits + sign).

The **BMEAHO0412** module offers the current range 4 - 20 mA for each of the inputs depending on the choice made during configuration.



BMEAHI0812

### References

#### HART analog input module

Type of input	Input signal range	Resolution	Connection via	No. of channels	Reference	Weight kg/lb
Isolated high-level inputs	4 - 20 mA	15 bits + sign	Caged, screw clamp, or spring-type 20-way removable terminal block	8 channels	<a href="#">BMEAHI0812</a>	0.233/ 0.514

#### HART analog output module

Type of input	Output signal range	Resolution	Connection via	No. of channels	Reference	Weight kg/lb
Isolated high-level outputs	4 - 20 mA	15 bits + sign	Caged, screw clamp, or spring-type 20-way removable terminal block	4 channels	<a href="#">BMEAHO0412</a>	0.223/ 0.492

(1) The **BMEAHI0812** HART analog input module loses its isolation between channels when connected to the Modicon Telefast **ABE7CPA03** sub-base.



### Presentation

**BMXEHC0200** and **BMXEHC0800** counter modules for the Modicon X80 I/O platform are used to count the pulses generated by a sensor or to process the signals from an incremental encoder.

The two modules differ in their number of counter channels, maximum input frequencies, functions, and auxiliary input and output interfaces:

Counter module	No. of channels	Maximum frequency	Integrated functions	No. of physical inputs	No. of physical outputs
<b>BMXEHC0200</b>	2	60 KHz	Upcounting Downcounting Period meter Frequency meter Frequency generator Axis control	6	2
<b>BMXEHC0800</b>	8	10 KHz	Upcounting Downcounting Measurement	2	–

The sensors used on each channel can be:

- 2-wire 24 V proximity sensors
- 3-wire 24 V proximity sensors
- 10/30 V output signal incremental encoders with push-pull outputs

**BMXEHC0200/0800** counter modules can be used to meet the demands of applications such as:

- Alarm generation on empty unwinder status using the ratio
- Sorting small parts using the period meter
- Single electronic cam using the dynamic setting thresholds
- Speed control using the period meter

These standard format modules can be installed in any available slot on a Modicon X80 I/O PLC. They are hot-swappable.

In a Modicon X80 I/O PLC configuration, the number of **BMXEHC0200/0800** counter modules should be added to the number of application-specific modules (communication). The function parameters are set by configuration using EcoStruxure Control Expert (1) software.

### Description

**BMXEHC0200/0800** counter modules are standard format. They occupy a single slot in **BM●XBP●●●** racks. They come in a plastic case, which provides IP20 protection of the electronics, and are locked into position by a captive screw.

#### BMXEHC0200 module, 2 channels, 60 KHz

The front panel of the **BMXEHC0200** counter module features:

- 1 Module and channel status display block
- 2 16-way connector for connecting the sensors of counter 0
- 3 16-way connector for connecting the sensors of counter 1
- 4 10-way connector for connecting:
  - Auxiliary outputs
  - Sensor power supplies

**To be ordered separately:**

- A **BMXXTSHSC20** kit containing two 16-way connectors and one 10-way connector
- A **BMXXSP●●00** shielding connection kit if the rack is not already equipped with one (see [page 2/5](#))

#### BMXEHC0800 module, 8 channels, 10 KHz

The front panel of the **BMXEHC0800** counter module features:

- 1 Module and channel status display block
- 2 Connector taking the **BMXFTB20●0** 20-way removable terminal block 3 (same as that of I/O modules)

**To be ordered separately:**

- A 20-way removable terminal block 3 (caged, screw clamp, or spring-type) (see [page 3/13](#))
- A **BMXXSP●●00** shielding connection kit if the rack is not already equipped with one (see [page 2/5](#))

(1) EcoStruxure Control Expert software continues the Unity Pro range of software and corresponds to versions ≥ 14 of Unity Pro.

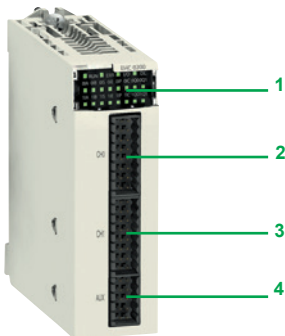

BMXEHC0200

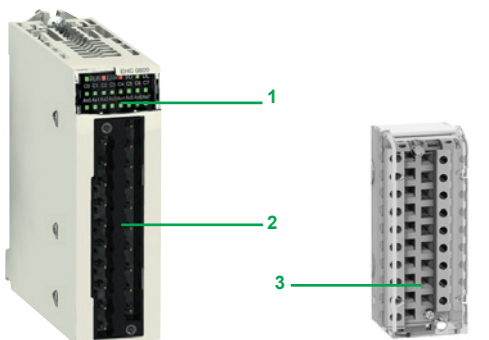

BMXEHC0800

BMXFTB20●0

### Operating modes for module BMXEHC0200

8 configurable modes	
Frequency meter	<p>This mode measures a frequency, speed, data rate, or an event stream. As standard, this mode measures the frequency received on the IN_A input. This frequency is expressed in Hz (number of pulses/second), with a precision of 1 Hz.</p> <p>The maximum frequency on the IN_A input is 60 kHz. The maximum cyclic ratio at 60 kHz is 60%.</p>
Event counting	<p>This mode is used to determine the number of events received. In this mode, the counter calculates the number of pulses applied to the IN_A input at time intervals defined by the user.</p> <p>The module counts the pulses applied to the IN_A input each time the pulse for this input lasts longer than 5 μs (without anti-bounce filter).</p>
Period measurement	<p>This mode is used to:</p> <ul style="list-style-type: none"> <li>■ Determine the duration of an event</li> <li>■ Determine the time between 2 events</li> <li>■ Time and measure the execution time of a process</li> </ul> <p>It measures the time elapsed during an event or between 2 events (IN_A input) according to a selectable time base of 1 μs, 100 μs, or 1 ms. The IN_SYNC input can be used to enable or stop a measurement. The module can carry out a maximum of 1 measurement every 5 ms. The shortest measurable pulse is 100 μs, even if the unit defined by the user is 1 μs. The maximum measurable duration is 4,294,967,295 units (unit to be defined).</p>
Ratio counting	<p>Ratio counting mode only uses the IN_A and IN_B inputs. There are 2 possible modes:</p> <ul style="list-style-type: none"> <li>■ Ratio 1: Used to divide 2 frequencies. This is intended for applications such as flowmeters, mixers, etc.</li> <li>■ Ratio 2: Used to subtract 2 frequencies. This is intended for the same applications, but for those requiring more precise regulation (more similar frequencies).</li> </ul> <p>Ratio 1 mode gives the results in thousandths for better accuracy (a display of 2,000 corresponds to a value of 2) and ratio 2 mode gives the results in Hz.</p> <p>The maximum frequency that the module can measure on the IN_A and IN_B inputs is 60 kHz.</p>
Downcounting	<p>This mode is used to list a group of operations. In this mode, activating the synchronization function starts the counter which, starting from a user-defined preset value, decreases with each pulse applied to the IN_A input, until it reaches 0. This downcounting is made possible when the enable function has been activated. The counting register is thus updated at 1 ms intervals.</p> <p>One basic use of this mode is to signal, using an output, the end of a group of operations (when the counter reaches 0).</p> <p>The shortest pulse applied to the IN_SYNC input is 100 μs. The maximum frequency applied to the IN_SYNC input is 1 pulse every 5 ms. The maximum user-defined preset value is 4,294,967,295. The maximum count value is 4,294,967,295 units.</p>
Loop (modulo) counting	<p>This mode is used in packaging and labeling applications where actions are repeated on sets of moving objects:</p> <ul style="list-style-type: none"> <li>■ In upcounting, the counter increases until it reaches the user-defined "modulo - 1" value. On the next pulse, the counter is reset to 0 and upcounting restarts.</li> <li>■ In downcounting, the counter decreases until it reaches 0. On the next pulse, the counter is reset to the user-defined "modulo - 1" value. Downcounting can then restart.</li> </ul> <p>The maximum frequency applied to the IN_A and IN_B inputs is 60 kHz. The maximum frequency of the modulo event is 1 event every 5 ms. The maximum modulo value is 4,294,967,296 (possible by declaring 0 in the modulo adjust value).</p>
32-bit counter counting	<p>This mode is mainly used in axis following.</p> <p>The maximum frequency applied simultaneously to the IN_A and IN_B inputs is 60 kHz. The maximum frequency of the referencing event is 1 event every 5 ms. The counter value is between -2,147,483,648 and +2,147,483,647.</p>
Width modulation	<p>In this operating mode, the module uses an internal clock generator to supply a periodic signal on the module's O0 output. Only the O0 output is affected by this mode, as the O1 output is independent of it.</p> <p>The maximum output frequency is 4 kHz. As O0 is a source output, a load resistor is necessary for the O0 output signal to change to 0 at the correct frequency. The cyclic ratio adjustment range varies according to the frequency of the O0 output.</p>

### Operating modes for module BMXEHC0800

<b>5 configurable 16-bit modes</b>	Frequency meter	<p>This mode measures a frequency, speed, rate, or data stream control. As standard, this mode measures the frequency received on the IN A input. This frequency is expressed in Hz (number of pulses per second), with a precision of 1 Hz.</p> <p>The maximum frequency on the IN A input is 10 kHz. The maximum cyclic ratio at 10 kHz is 60%.</p>
	Event counting	<p>This mode is used to determine the number of events received. In this mode, the counter calculates the number of pulses applied to the IN_A input at time intervals defined by the user. As an option, it is possible to use the IN_AUX input during a period of time, provided that the enable bit has been configured.</p> <p>The module counts the pulses applied to the IN_A input each time the pulse for this input lasts longer than 50 μs (without anti-bounce filter). Pulses with less than 100 ms synchronization are lost.</p>
	Downcounting	<p>This mode is used to list a group of operations. In this mode, when counting is enabled (software validation via the valid_sync command), a rising or falling edge on the IN_AUX input causes a value, defined by the user, to be loaded in the counter. The latter decreases with each pulse applied to the IN_A input until it reaches the value 0. Downcounting is made possible when the force_enable command is high (software positioning).</p> <p>The smallest pulse applied to the IN_AUX input varies according to the selected filter level. The maximum frequency applied to the IN_AUX input is 1 pulse every 25 ms.</p>
	Loop (modulo) counting	<p>This mode is used in packaging and labeling applications where actions are repeated on sets of moving objects. The counter increases with each pulse applied to the IN_A input until it reaches the user-defined "modulo - 1" value. On the next pulse in the upcounting direction, the counter is reset to 0 and upcounting restarts.</p> <p>The maximum frequency applied to the IN_A input is 10 kHz. The smallest pulse applied to the IN_AUX input varies according to the selected filter level. The maximum frequency of the modulo event is 1 event every 25 ms. The maximum modulo value is 65,536 units.</p>
	Up/down counter	<p>This mode is used for an accumulation, upcounting, or downcounting operation on a single input. Each pulse applied to the IN_A input produces:</p> <ul style="list-style-type: none"> <li>■ Upcounting of pulses if the IN_AUX input is high</li> <li>■ Downcounting of pulses if the IN_AUX input is low</li> </ul> <p>The counter values vary between the limits -65,536 and +65,535. The maximum frequency applied to the IN_A input is 10 kHz. Pulses applied to the IN_A input after a change of direction are only upcounted or downcounted after a period corresponding to the delay for taking account of the state of the IN_AUX input due to the programmable filter level on this input.</p>
<b>One 32-bit mode</b>	32-bit counter counting	<p>32-bit counter counting mode is available for channels 0, 2, 4, and 6 (channels 1, 3, 5, and 7 are now inactive). It behaves in the same way as the up/down counting mode using up to 3 physical inputs. It enables simultaneous upcounting and downcounting.</p> <p>The counter values vary between the limits -2,147,483,648 and +2,147,483,647 (31 bits + sign). The maximum frequency applied to the IN_A and IN_B inputs is 10 kHz. The smallest pulse applied to the IN_AUX input is defined according to the filtering applied to this input. The maximum frequency of loading the preset value is 1 every 25 ms.</p>



BMXEHC0200



BMXEHC0800

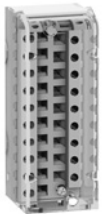

BMXFTB2000

### References

#### BMXEHC0200/0800 counter modules (1)

Description	No. of channels	Characteristics	Reference	Weight kg/lb
<b>Counter modules</b> for 24 V ---	2	60 kHz counting	<a href="#">BMXEHC0200</a>	0.112/ 0.247
2 and 3-wire sensors and 10/30 V --- incremental encoders with push-pull outputs	8	10 kHz counting	<a href="#">BMXEHC0800</a>	0.113/ 0.249

#### Connection accessories (2)

Description	Composition	Unit reference	Weight kg/lb
<b>Pack of connectors</b> for BMXEHC0200 module	Two 16-way connectors and one 10-way connector	<a href="#">BMXXTSHSC20</a>	0.021/ 0.046
<b>20-way removable terminal blocks</b> for BMXEHC0800 module	Caged	<a href="#">BMXFTB2000</a>	0.093/ 0.205
	Screw clamp	<a href="#">BMXFTB2010</a>	0.075/ 0.165
	Spring	<a href="#">BMXFTB2020</a>	0.060/ 0.132

<b>Shielding connection kit</b> for BMXEHC0200/0800 modules	Comprising a metal bar and two support bases for mounting on rack modules	See <a href="#">page 2/5</a>	–
---	---	------------------------------	---

(1) Typical consumption: See the power consumption table available on our website [www.schneider-electric.com](http://www.schneider-electric.com).

(2) The shielding on the cordsets carrying the counter signals must always be connected to the [BMXXSP0000](#) shielding connection kit mounted under the rack that holds the [BMXEHC0200](#) module (see [page 2/3](#)).



BMXERT1604T/BMXERT1604H

### Presentation

The time-stamping module is a complete solution providing a SCADA with a sequence of events that are time-stamped at source, enabling the user to analyze the source of any abnormal behavior in an automated system.

The SOE (sequence of events) is displayed in the alarms log or in the list of events for a client such as a SCADA.

Each event in the SOE is a change of value (transition) of a discrete I/O detected by a time-stamping module.

### Advantages

Using the time-stamping system has the following advantages:

- No PLC programming
- Direct communication between the time-stamping modules and the client; if the time-stamping modules are in a Quantum Ethernet I/O drop, the bandwidth of the PLC communication is not used
- Consistency of the I/O values between the process (time-stamping modules) and the client
- Consistency is maintained irrespective of the operating mode
- No loss of events under normal operating conditions
- Management of Hot Standby configurations on the PLC and/or SCADA redundancy

### Composition of a time-stamping architecture

#### BM●CRA312●0 module

This time-stamping module can be at the source of any discrete I/O signal located in the drop with a resolution of 10 ms.

To help ensure no event is lost, all events are stored and kept in a buffer located in the product until OFS takes them.

Synchronization of the CRA module uses the NTP protocol.

#### BMXERT1604T/H module

This module has 16 discrete inputs which carry out the time-stamping at source outputs with a resolution of 1 ms.

To help ensure no event is lost, all events are stored and kept in a buffer located in the product until OFS takes them.

This module can be placed either in an RIO drop, or in a local rack equipped with a BM●CRA31210 module.

The CRA module is synchronized via the DCF 77 or IRIG-B standards.

#### OFS V3.60

OFS V3.60 is used to access events stored in the various buffers in the architecture and to place them in the SCADA via the standard OPC DA protocol. For further information, consult our website [www.schneider-electric.com](http://www.schneider-electric.com).

#### Vijeo Citect V7.40

Vijeo Citect V7.40 receives events transmitted by OFS and displays them in the SOE or in the list of alarms.

### Performance

Performance	Event source module	Value
Between two identical source modules in the same rack	BMXERT1604T	1.6 < resolution < 3.3 ms
	BMXERT1604H	
	BM●CRA31210	10 ms
Between two different inputs in the same source module	BMXERT1604T	1 ms
	BMXERT1604H	
	BM●CRA31210	1 scan
Maximum number of events scanned	BMXERT1604T	400 events (1)
	BMXERT1604H	
	BM●CRA31210	2,048 events (1)
Maximum number of I/O and memory available	BMXERT1604T	16 discrete inputs on module
	BMXERT1604H	512 events in internal buffer
	BM●CRA31210	256 discrete I/O configured 4,000 events in internal buffer
Maximum number of source modules in an Ethernet remote drop	BM●CRA31210	1 per drop
	BMXERT1604T	
	BMXERT1604H	9 per drop
Maximum number of event sources controlled	BMXERT1604T BMXERT1604H	500 sources per second (1)

### References

#### BMXERT1604T/H time-stamping modules

Description	Input type	Reference	Weight kg/lb
Multifunction time-stamping input module	16 discrete inputs	BMXERT1604T	0.119/
		BMXERT1604H	0.262

#### Connection accessories for time-stamping modules

Description	For use with modules	Type, composition	Length	Reference	Weight kg/lb
28-way removable terminal blocks	BMXERT1604T BMXERT1604H	Caged	–	BMXFTB2800	0.111/ 0.245
		Spring	–	BMXFTB2820	0.080/ 0.176

(1) This maximum value is not an absolute value. It depends on the overall system dynamics (total number of scanned items and number of events generated by the system).

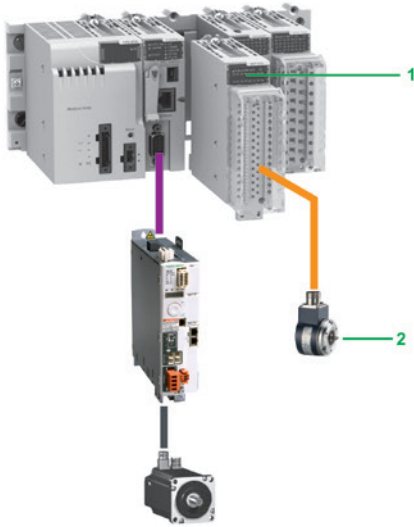

Modicon X80 I/O platform with Modicon M340 processor

### Presentation

The **BMXEAE0300** SSI encoder interface module **1** for the Modicon automation platform (1) is a 3-channel standard synchronous serial interface module designed for use with SSI absolute encoders **2**.

The **BMXEAE0300** module enables SSI encoder values to be processed on PAC platforms for applications requiring accurate position/angular control, such as:

- Hydro power, e.g. dam inlet gate position control
- Wind power, e.g. wind turbine blade pitch control
- Complex motion loop control, e.g. ship elevator, blast furnace, flame cutting, etc.

The **BMXEAE0300** module provides a migration path from Premium (with **TSXCTY2C** measurement and counter module) to the Modicon X80 I/O platform SSI solution to compete in the above market segments.

Like any other application-specific module, the **BMXEAE0300** module is installed in the rack slots (01 to 11). The number of modules is limited by the maximum number of application-specific channels permitted according to the CPU type (consult our website [www.schneider-electric.com](http://www.schneider-electric.com)).

### Dam inlet gate control

Inlet gate control enables the water level in a dam to be monitored and controlled:

- The SSI encoder provides the PLC with accurate feedback of the gate position for precise monitoring of gate opening, adjustment, and positioning.
- The SSI interface converts the signals from the SSI encoders and transmits them to the CPU.

### Wind turbine blade pitch control

Pitch control is required for adjusting the angle of the wind turbine blades in relation to the wind direction and strength, in order to achieve optimum energy conversion efficiency.

- The SSI absolute encoder is frequently used to feed back the position of the blade due to its reliability and robustness.
- Typically, the position of each of the three blades is read by the SSI encoders and then transmitted to the CPU via the SSI interface for motion loop control.

Sometimes, 3 additional SSI inputs act as backup. Therefore, this new offer is adequately sized for the channel density.

### Description

The **BMXEAE0300** SSI encoder interface module is standard format (1 slot). Its housing provides IP20 protection of the electronics and it is locked in each slot (**01** to **11**) by a captive screw.

The front panel of the **BMXEAE0300** module features:

- 1** A rigid housing providing support and protection for the electronic card
- 2** The module reference marking (a label is also visible on the right-hand side of the module)
- 3** A display block indicating:
  - Module status via 4 LEDs:
    - RUN (green): module operating status
    - ERR (red): internal fault detected in the module or a fault detected between the module and the rest of the configuration
    - I/O (red): external fault detected
    - DL (green): firmware download status
  - Status of the 3 SSI channels via 8 LEDs:
    - Sx (green): channel x input (x = 0, 1, or 2)
    - Qx (green): reflex output for channel x (x = 0, 1, or 2)
    - IO/1 (green): capture inputs for the 3 SSI channels
- 4** A connector for a 28-way terminal block, for connecting to a removable caged or spring terminal block on sensors and preactuators

**To be ordered separately:**

- 5** A 28-way removable caged terminal block **BMXFTB2800** or spring terminal block **BMXFTB2820**, supplied with a channel identification label
  - A shielding connection kit to help protect against electrostatic discharge, consisting of a metal bar and two sub-bases for mounting on the rack: **BMXXSP●●00** (reference dependent on the number of slots in the rack) (see [page 2/5](#))
  - A set of clamping rings **STBXSP30●0** for the connection cable shielding braids (reference dependent on the cable diameter) (see [page 2/5](#))

(1) Only for the Modicon automation platforms compatible with Modicon X80 I/O platform

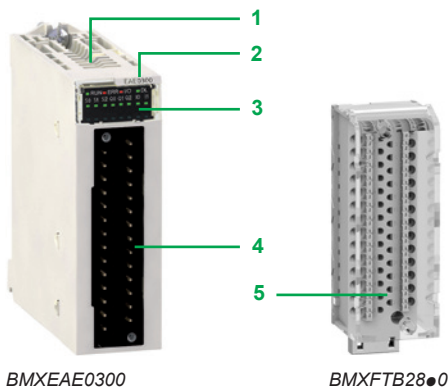

BMXEAE0300

BMXFTB2800

### Module specifications and functions

#### Specifications

The SSI module **BMXEAE0300** is a 3-channel, synchronous serial interface, absolute encoder interface for Modicon PLCs. It supports:

- 3 channels of SSI inputs (DATA pair, CLK pair, 24 VDC field power supply to encoder)
- 1 reflex output for each SSI channel (Q)
- 2 capture inputs for the 3 SSI channels (CAP\_IN0, CAP\_IN1)
- 8 to 31 bits data width
- 4 baud rates (100 kHz, 200 kHz, 500 kHz, and 1 MHz)
- Capture and compare functions

#### Basic and optional functions

The following table presents the main functions of the **BMXEAE0300** module:

Function	Basic/ optional	Description
Absolute SSI encoder value acquisition	Basic	The position values of the SSI channel are automatically read by the module within 1 ms, unless the channel is disabled.
Modulo	Optional for motion	The modulo function limits the dynamics of the position value to within the power of 2. An event (if enabled) detects the passing of the modulo. The reflex output can also be detected when the modulo is passed (if configured).
Reduction	Optional for motion	This function reduces the intrinsic resolution of the encoder by a value defined by the "reduction" parameter. This reduction is carried out by a shift in the bit field provided by the encoder.
Offset	Optional for motion	The correction function of the encoder offset systematically corrects the offset produced by the encoder at mechanical position "0". The user enters the absolute encoder offset parameter.
Capture	Optional for events	The two capture input registers (per channel) enable the PLC program to carry out a dynamic measurement function between two points. The capture action can be triggered by two capture inputs. The event will be triggered at each capture.
Compare	Optional for events	Two independent comparators (per channel), with thresholds that can be modified by adjustment (explicit exchange), are able to generate an event or reflex output when the threshold is crossed.

#### Main features

- Supported by EcoStruxure Control Expert (1).
- Supports absolute encoder 24 V model with standard SSI interface, including Telemecanique Sensors OsiSense SSI encoders. For further information, consult the website [www.tesensors.com](http://www.tesensors.com).
- Standards and approvals: CE, UL, CSA, C-Tick, GOST, etc.

### References

#### SSI encoder interface module (2)

Description	Number of channels	Description per channel	Reference	Weight kg/lb
SSI encoder interface module	3 SSI channels	1 reflex output for each SSI channel	<b>BMXEAE0300</b>	0.138/
		2 capture inputs for the 3 SSI channels 8 to 31 bits data width 4 baud rates: 100 kHz, 200 kHz, 500 kHz, 1 MHz Capture and compare functions		0.304

#### Cabling accessories

Description	Description, use	Reference	Weight kg/lb
28-way removable terminal block	Caged	<b>BMXFTB2800</b>	0.111/ 0.245
	Spring	<b>BMXFTB2820</b>	0.080/ 0.176
Shielding connection kit for BMXEAE0300 module (3)	Comprising a metal bar and two support bases for mounting on rack	See <a href="#">page 2/5</a>	–

(1) EcoStruxure Control Expert software continues the range of Unity Pro software and corresponds to versions  $\geq 14$  of Unity Pro.

(2) Typical consumption: See the power consumption table available on our website [www.schneider-electric.com](http://www.schneider-electric.com).

(3) The shielding on the cables carrying the power supply to the module, each SSI channel, the capture inputs, and the reflex outputs (if any of them is wired) must always be connected to the **BMXXSP●●00** shielding connection kit mounted under the rack holding the **BMXEAE0300** module (see [page 2/3](#)).



BMXEAE0300



BMXFTB28●0



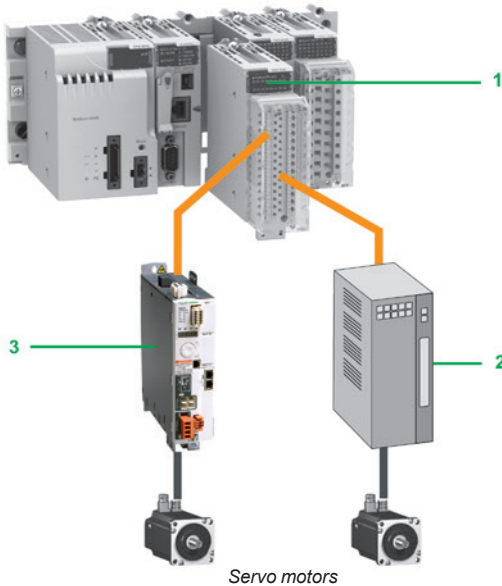

Servo motors

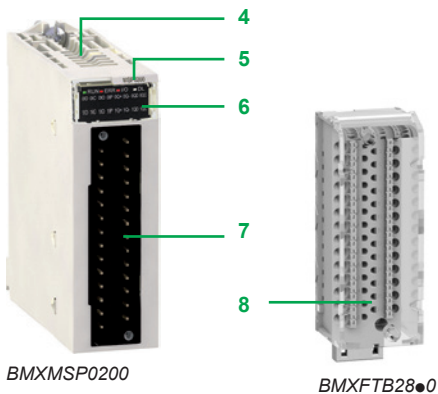

BMXMSP0200

BMXFTB2800

### Presentation

The **1 BMXMSP0200** motion control pulse train output (PTO) module for the Modicon X80 I/O platform is used for controlling third-party variable speed drives **2**, which have an integrated position loop and inputs that are compatible with open collector outputs.

The **BMXMSP0200** control module is also directly compatible with the Lexium 32C and 32M **3** servo drive ranges, which have an integrated pulse control interface.

The **BMXMSP0200** motion control PTO module has two independent PTO channels. Like any other application-specific module, it is installed in the rack slots (labeled **01** to **11**). The number of modules is limited by the maximum number of application-specific channels permitted according to the CPU type:

- Standard **BMXP341000**: Maximum of 20 application-specific channels (1)
- Performance **BMXP342000**: Maximum of 36 application-specific channels (1)
- **BMEP5810**: Maximum of 24 application-specific channels (1)
- **BMEP5820**: Maximum of 32 application-specific channels (1)
- **BMEP5830** and **BMEP5840**: Maximum of 64 application-specific channels (1)
- **BMEP585040**: Maximum of 180 application-specific channels (1)
- **BMEP586040**: Maximum of 216 application-specific channels (1)

### Description

The **BMXMSP0200** motion control module is standard format (1 slot). Its housing provides IP20 protection of the electronics and it is locked in each slot (**01** to **11**) by a captive screw.

The front panel of the **BMXMSP0200** motion control module features:

- 4** A rigid body providing support and protection for the electronic card
- 5** A module reference marking (a label is also visible on the right-hand side of the module)
- 6** A display block indicating:
  - Module status via 4 LEDs (RUN, ERR, I/O, and DL)
  - Status of the auxiliary inputs, 4 per channel
  - Status of the PTO outputs, 2 per channel
  - Status of the auxiliary outputs, 2 per channel
- 7** A connector for a 28-way terminal block, for connecting to a removable spring terminal block on sensors and preactuators

**To be ordered separately:**

- 8** A 28-way removable caged terminal block **BMXFTB2800** or spring terminal block **BMXFTB2820**, supplied with a channel identification label
  - A shielding connection kit to help protect against electrostatic discharge, consisting of a metal bar and two sub-bases for mounting on the rack: **BMXXSP0000** (reference dependent on the number of slots in the rack) (see [page 2/5](#))
  - A set of clamping rings **STBXSP3000** for the connection cable shielding braids (reference dependent on the cable diameter) (see [page 2/5](#))

(1) Application-specific channels: **BMXEHC0200** (2-channel) and **BMXEHC0800** (8-channel) counter modules, **BMXMSP0200** (2-channel) motion control module, **BMXNOM0200** (2-channel) and **BMXNOR0200H** (1-channel) serial communication modules, **BMEAH10812** (8-channel) analog input module and **BMEAH00412** (4-channel) analog output module, **BMXAE0300** (3-channel) SSI module and **BMXERT1604T/H** (16-channel) discrete input module.

### Operation

#### Block diagram of a BMXMSP0200 module channel

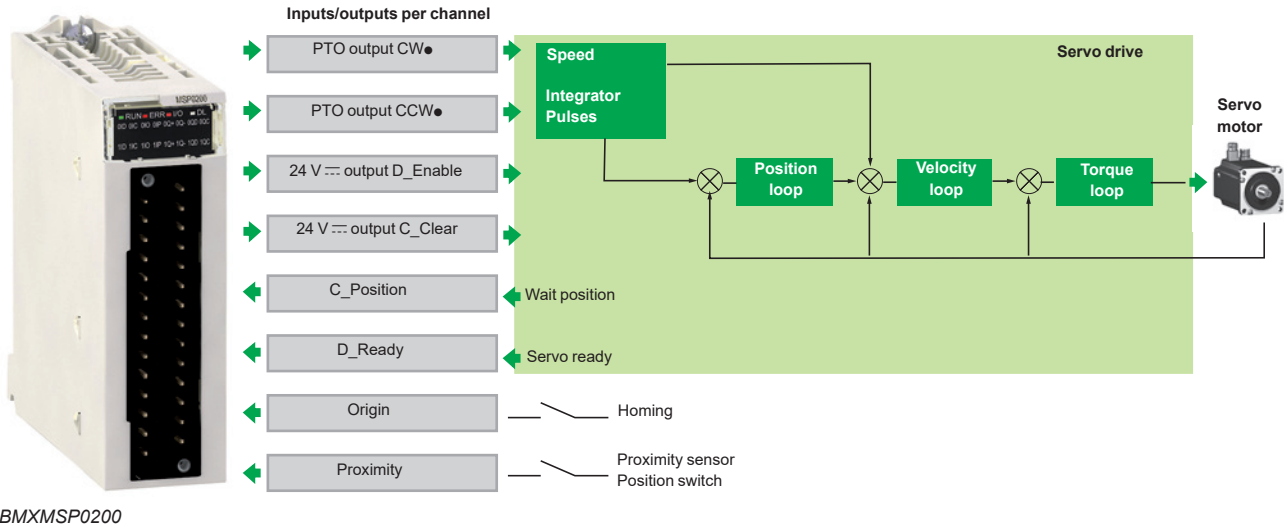

BMXMSP0200

### References

#### Motion control modules (1)

Description	Number of channels	Description per channel	Reference	Weight kg/lb
PTO module	2	2 x 200 kHz max. PTO outputs 2 x 24 V $\overline{\text{---}}$ /50 mA auxiliary outputs 4 x 24 V $\overline{\text{---}}$ auxiliary inputs	<a href="#">BMXMSP0200</a>	0.145/ 0.320

#### Cabling accessories

Description	Description, use	Length	Reference	Weight kg/lb
28-way removable terminal block	Caged	–	<a href="#">BMXFTB2800</a>	0.111/ 0.245
	Spring	–	<a href="#">BMXFTB2820</a>	0.080/ 0.176



BMXMSP0200



BMXFTB2800

<b>Connection cable</b> for daisy chain or pulse control (2)	From BMXMSP0200 (screw terminal block) module to Lexium 32C or 32M (RJ45 connector) (cable with flying leads at one end and an RJ45 connector at the other)	3 m/9.84 ft	<a href="#">VW3M8223R30</a>	–
--	---	-------------	-----------------------------	---

<b>Shielding connection kit</b> for module BMXMSP0200	Comprising a metal bar and two support bases for mounting on rack	–	See <a href="#">page 2/5</a>	–
---	---	---	------------------------------	---

(1) Typical consumption: See the power consumption table available on our website [www.schneider-electric.com](http://www.schneider-electric.com).  
 (2) The shielding on the cordsets carrying the motion control signals must always be connected to the **BMXXSP●●00** shielding connection kit mounted under the rack holding the **BMXMSP0200** module (see [page 2/3](#)).

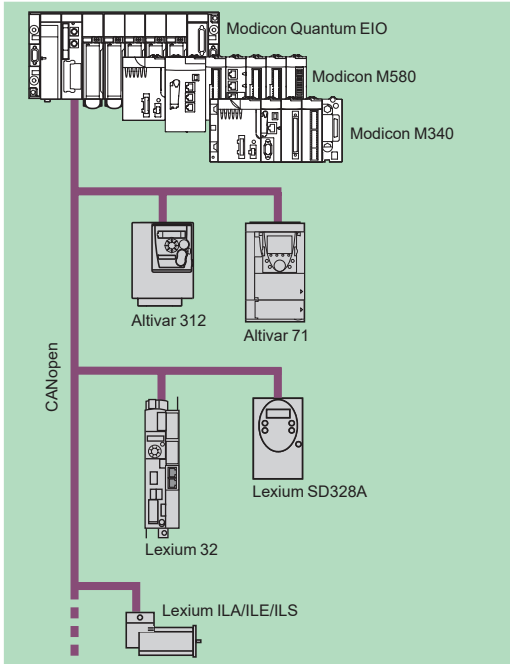

MFB: Motion control distributed over CANopen

### Presentation

MFB (Motion Function Blocks) is a library of function blocks integrated in EcoStruxure Control Expert (1) used to set up motion control in the architectures of drives and servo drives on CANopen buses:

- Altivar 312: For asynchronous motors from 0.18 to 15 kW/0.25 to 20 HP
- Altivar 71: For synchronous or asynchronous motors from 0.37 to 500 kW/0.5 to 700 HP
- Lexium 32: For servo motors from 0.15 to 7 kW/0.20 to 10 HP
- Lexium ILA/ILE/ILS: Integrated motor drives from 0.10 to 0.35 kW/0.13 to 0.47 HP
- Lexium SD328A: For 3-phase stepper motors from 0.35 to 0.75 kW/0.47 to 1 HP

In compliance with PLCopen specifications, the MFB library allows both easy and flexible motion programming with EcoStruxure Control Expert (1), as well as axis diagnosis.

In maintenance operations, drives can be replaced quickly thanks to drive parameter download blocks.

Setting up drives on the CANopen network is facilitated through Motion Tree Manager organization in the EcoStruxure Control Expert (1) browser, making it easy for users to access the application drives.

### Applications

The features of the Motion Function Blocks library are particularly suitable for machines with independent axes. In the case of these modular/special machines, MFB function blocks are an ideal solution for controlling single axes. The following are typical applications for this type of architecture:

- Automatic storage/removal
- Material handling
- Palletizers/depalletizers
- Conveyors
- Packaging, simple labeling application
- Grouping/ungrouping
- Adjustment axes in flexible machines, etc.

### Functions

The table below lists the function blocks of the MFB library and the compatible drives. The prefix indicates the block family:

- MC: Function block defined by the Motion Function Blocks PLC Open standard
- TE: Function block specific to Schneider Electric products
- Lxm: Function block specific to Lexium servo drives



Type	Function	Function block	Altivar 312	Altivar 71	Lexium 32	Lexium ILA/ILE/ILS	Lexium SD328A
Management and motion	Read an internal parameter	MC_ReadParameter					
	Write an internal parameter	MC_WriteParameter					
	Read the current position	MC_ReadActualPosition					
	Read the instantaneous speed	MC_ReadActualVelocity					
	Acknowledge detected error messages	MC_Reset					
	Stop any active movement	MC_Stop					
	Axis coming to standstill	MC_Power					
	Movement to absolute position	MC_MoveAbsolute					
	Relative movement	MC_MoveRelative					
	Additional movement	MC_MoveAdditive					
	Homing	MC_Home					
	Movement at given speed	MC_MoveVelocity					
	Read diagnostic data	MC_ReadAxisError					
	Read servo drive status	MC_ReadStatus					
	Torque control	MC_TorqueControl					
	Read actual torque value	MC_ReadActualTorque					
Manual control	MC_Jog						
Save and restore parameters (FDR)	Read drive parameters and store in PLC memory	TE_UploadDriveParam					
	Write drive parameters from PLC memory	TE_DownloadDriveParam					
Advanced Lexium functions	Read a motion task	Lxm_UploadMTask					
	Write a motion task	Lxm_DownloadMTask					
	Start a motion task	Lxm_StartMTask			(1)		
	Set the reduction ratio, signed	Lxm_GearPosS			(1)		
System	Communication with the servo drive	TE_CAN_Handler					

Compatible

(1) The Lxm\_StartMTask and Lxm\_GearPosS function blocks are only compatible with Lexium 32 (LXM32M) servo drives.

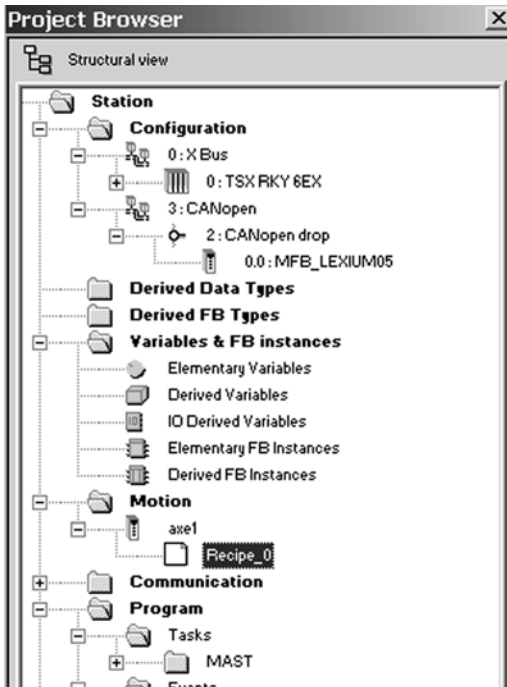

Motion Tree Manager integrated in the EcoStruxure Control Expert browser

### Motion Tree Manager

Motion Tree Manager is associated with MFB library of EcoStruxure Control Expert (1) and integrated in its browser. It provides specific assistance for:

- Axis object management
- Axis variable definition
- Drive parameter management

Motion Tree Manager automatically creates links between the CANopen bus configuration and the MFB function block data using a limited amount of configuration data.

### General axis parameters

In this tab, the designer is prompted to define:

- The name of the axis that will identify it in the browser for the entire application
- The address of the drive on the CANopen bus

### Axis parameters

The drop-down lists in this tab are used to determine the exact type of drive: family, version.

### Variable names

This last tab is used to identify data structures:

- **Axis\_Reference**: Used by the function block instances for the axis in question
- **CAN\_Handler**: Used to manage communication with the drive via the CANopen network

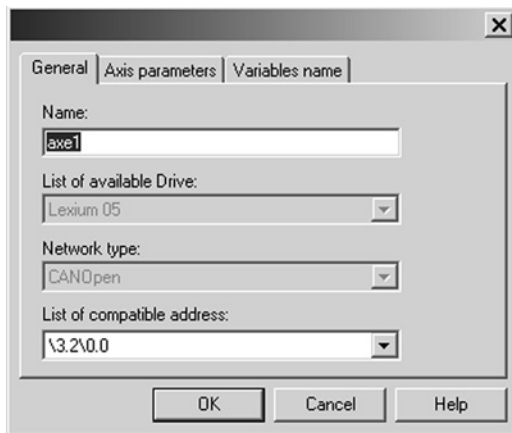

General parameters: Axis name and address

### Recipe definition

The “recipes” attached to the axis are the data structures containing the adjustment parameters of a given drive. This data is used when:

- Changing the drive with restoration of the context during “Faulty Device Replacement” (FDR) maintenance
- Changing the manufacturing program of the machine and calling up an appropriate set of parameters: servo control gains, limitations, etc. adapted to the weight and size of the moving parts
- Saving parameters in the initial values of the PLC application

### Programming, diagnostics, and maintenance

Communication between the PLC and drive is automatically set up by the system as soon as a TE\_CAN\_Handler instance is declared in the EcoStruxure Control Expert (1) task with which the axis is associated. Movements are then programmed by sequencing function blocks from the library in the user's chosen EcoStruxure Control Expert (1) editor (LD, ST, FBD).

The two function blocks, MC\_ReadStatus, and in some cases MC\_ReadAxisError, are useful for determining the overall status of the axis, as well as the code of the active detected errors.

The function blocks TE\_UploadDriveParam and TE\_DownloadDriveParam allow the application to save the drive parameters (recipe) and to then quickly reload them into another drive when it is necessary to change the original one.

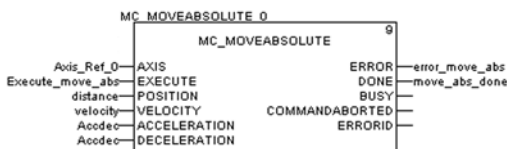

MFB: Programming a movement in absolute mode

(1) EcoStruxure Control Expert software continues the Unity Pro range of software and corresponds to versions ≥ 14 of Unity Pro.

### Presentation

The **BMXETM0200H** frequency input module offers turbine shaft and engine speed monitoring functionality for general purpose turbomachinery control (TMC) applications. It can be integrated into Modicon M340 and M580 standard and high-availability systems.

TMC applications include prime movers, driven equipment, auxiliaries, mechanical retrofits, and protection. With the Modicon Package solution, the frequency input and measurement function is available for the following general purpose TMC application types:

- Large hydro turbines
- Small steam turbine generators
- Small hydro turbines
- Small mechanical drive gas turbines
- Diesel generators
- Reciprocating compressors
- Packaged air compressors
- Single-stage mechanical drive turbines: pumps

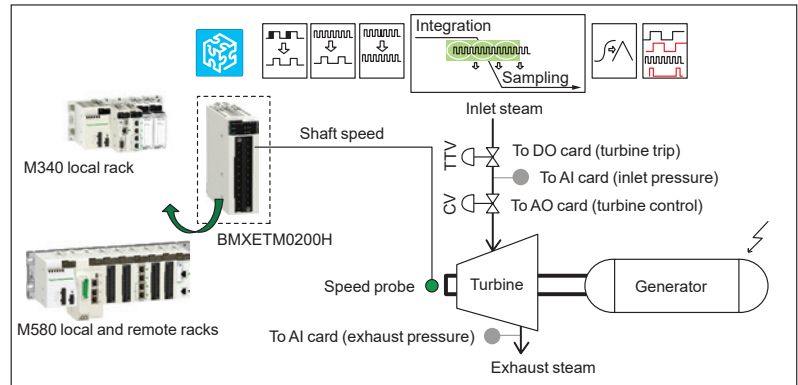

TMC governor control system architecture

### Functionality

The purpose of the **BMXETM0200H** module is to monitor the turbine shaft or engine speed. It is designed to receive electrical pulses generated by the gear tooth sensing probe, cam, and crank etc. and convert these pulses into a numerical value. The measured value of the turbine shaft rotating velocity is highly accurate with a fast refresh rate.

With the **BMXETM0200H** module providing frequency input and measurement, Modicon PACs build up a closed loop control system as part of the turbomachinery governor. This control mechanism will automatically track and direct the speed of driven equipment (such as a generator or compressor) and a prime mover (such as a turbine or engine) under varying load conditions with the aim of:

- maintaining the selected speed
- limiting slow and fast speeds
- helping to protect mechanical parts and customer investment by anticipating overspeeds by means of its acceleration and jerk detection capability



BMXETM0200H

### Module specifications

#### Availability and compatibility

Available for Modicon M340 and M580 standalone and HSBY platforms, on local rack or RIO rack with hot swapping supported.

#### Ambient operating temperature

Hardened with extended temperature range from  $-25...70\text{ }^{\circ}\text{C}/-13...158\text{ }^{\circ}\text{F}$  and conformal coating.

#### Measurement performance

Two frequency input channels for 1 V and 1 Hz signal up to a maximum of 500 KHz with 100 KHz, 10 KHz, and 1 KHz input filters.

#### Supported signal source device type

Speed sensor inputs support passive pickup, active speed sensor (output OC, TTL, ST), potential transformer, and incremental encoder.

#### Digital reflex outputs

1 positive 24 VDC reflex digital output per channel controlled from an embedded comparator.

#### Error detection

Detects broken wire and probe health status.

#### Dedicated TMC functions

A set of dedicated TMC functions for turbine shaft monitoring, including:

- Frequency pattern recognition up to 512 pulses per pattern
- Acceleration and jerk detection
- Phase angle and ratio detection between channels
- Scaling factor for RPM measurement up to 1,024 teeth per revolution
- Alarm bits that can be time-stamped by the Modicon M580 controller

#### Software configuration

Configurable using EcoStruxure Control Expert (1) or Unity Pro V11 (S, L, and XL) with TMC Hotfix integrated.

### Reference

#### Frequency input module

Description	Composition	Reference	Weight kg/lb
Ruggedized turbomachinery frequency input module (2 channels)	1 ms cycle time 2 digital reflex outputs 2 discrete inputs (for frequency measurement functions)	<a href="#">BMXETM0200H</a>	0.124/ 0.273

(1) EcoStruxure Control Expert software continues the Unity Pro range of software and corresponds to versions  $\geq 14$  of Unity Pro.



---

*Selection guide* ..... page 4/2

## **X80 Safety power supply modules**

- Presentation, description ..... page 4/4
- Functions, references ..... page 4/5

## **X80 Safety discrete I/O modules**

- Presentation..... page 4/6
- Description, connections ..... page 4/7
- References ..... page 4/8

## **X80 Safety analog I/O module**

- Presentation, description, connections ..... page 4/9
- References ..... page 4/9



Applications		16-channel Safety discrete input module
		
Type	DC	
Voltage	24 V	
Current per channel	3.5 mA	
Range	Voltage	–
	Current	–
Modularity	Number of channels	16
	Number of groups	2: 0...3 (banks A & B) and 4...7 (banks A & B)
	Number of channels per common	8
Acquisition period	Hot-swap RAID HDD and battery backup	–
Resolution	–	
Connection	Via 20-way caged, screw clamp, or spring-type removal terminal block BMXFTB2000/2010/2020	
Isolated inputs	IEC/EN 61131-2 conformity	Type 3
	Logic	Positive
	Type of input	–
	Sensor compatibility IEC/EN 60947-5-2	2-wire/3-wire
Isolated outputs	Fallback	–
	IEC/EN 61131-2 conformity	–
	Protection	–
	Logic	–
Isolation	Between channels	Non-isolated
	Between channels and bus	1500 Vrms
	Between channels and ground	1500 Vrms
Sensor power supply (ripple included)	19...30 V	
Preactuator power supply (ripple included)	–	
Protection of inputs	Use a fast-blow fuse, max 0.5 A, depending on the module current load	
Output fuse protection	–	
Maximum dissipated power	3.57 W	
Conformal coated	Yes	
Operating temperature	-25...60 °C/-13...140 °F	
References	<b>BMXSDI1602</b>	

8-channel Safety discrete output module	4-channel Safety relay output module	4-channel Safety analog input module
		
		
		
DC	AC/DC relays	Current
24 V	24 V $\overline{\text{---}}$ /24...230 V $\sim$	–
0.5 A	5 A	–
–	–	6
–	–	4...20 mA
8	4 isolated outputs	4 isolated inputs
1		
–		
–		5 ms for the 4 inputs
–		16 bits (12,500 counts)
Via 20-way caged, screw clamp, or spring-type removal terminal block BMXFTB2000/2010/2020		
–		
–		
–		Resistive
–		
Configurable fallback setting for each channel	–	
Yes		–
Yes		–
Positive	–	
Non-isolated	3000 Vrms	500 Vrms
1500 Vrms	3000 Vrms	1500 Vrms
1500 Vrms	3000 Vrms	1500 Vrms
–		
19...30 V	10...264 V $\sim$ /10...34 V $\overline{\text{---}}$	–
–		
Use a fast-blow fuse, max 6 A, depending on the module current load	Use a fast-blow fuse, max 6 A, depending on the relay contact current load	–
4.40 W	3.90 W	3.98 W
Yes	Yes	Yes
-25...60 °C/-13...140 °F		
<b>BMXSDO0802</b>	<b>BMXSRA0405</b>	<b>BMXSAI0410</b>

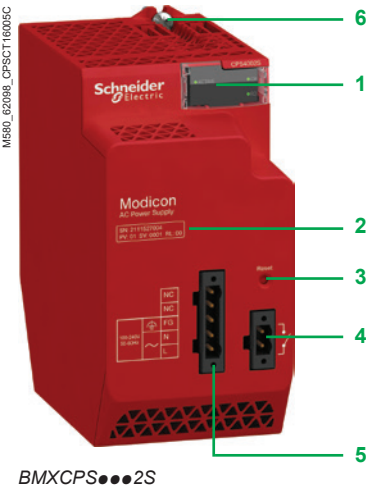

BMXCPS...2S

### Presentation

The Safety power supply in the Modicon X80 I/O offer is the **BMXCPS...2S**.

The **BMXCPS4022S** power supply module:

- Converts 24...48 V  $\overline{\text{---}}$  power into two output voltages, 24 V  $\overline{\text{---}}$  and 3.3 V  $\overline{\text{---}}$ , which are distributed over the backplane
- Detects overvoltage, overload, and short-circuit conditions on both the 3.3 V  $\overline{\text{---}}$  and 24 V  $\overline{\text{---}}$  backplane lines

The **BMXCPS3522S** power supply module:

- Converts 100...150 V  $\sim$  power into two output voltages, 24 V  $\overline{\text{---}}$  and 3.3 V  $\overline{\text{---}}$ , which are distributed over the backplane
- Detects overvoltage, overload, and short-circuit conditions on both the 3.3 V  $\overline{\text{---}}$  and 24 V  $\overline{\text{---}}$  backplane lines

The **BMXCPS4002S** power supply module:

- Converts 110...240 V  $\sim$  power into two output voltages, 24 V  $\overline{\text{---}}$  and 3.3 V  $\overline{\text{---}}$ , which are distributed over the backplane
- Detects overvoltage, overload, and short-circuit conditions on both the 3.3 V  $\overline{\text{---}}$  and 24 V  $\overline{\text{---}}$  backplane lines, and allows a maximum voltage of 30 V  $\overline{\text{---}}$

### Description

The **BMXCPS...2S** power supply module includes:

- 1 Display panel comprising LEDs with various combinations to provide quick diagnostics of the power supply module status:
  - ACTIVE LED (green): On when the power supply is the master power supply, off when it acts as a slave supply in a redundant application
  - OK LED (green): On if the rack voltages are present and correct
  - RD LED (green): On when all the internal power supply modules function normally
- 2 Printed serial number and product version
- 3 Pencil-point Reset pushbutton for a cold restart of the application
- 4 2-way connector that can take a removable terminal block (caged or spring-type) for connecting the alarm relay
- 5 A 5-way connector that can take a removable terminal block (caged or spring-type) for connecting the following:
  - AC or DC line supply
  - Protective ground
- 6 1 hook and 1 screw for mechanical attachment and grounding connection to the backplane

**Included with each power supply module:** Set of two caged removable terminal blocks (5-way and 2-way) **BMXXTSCPS10**

**To be ordered separately (if necessary):** Set of two spring-type removable terminal blocks (5-way and 2-way) **BMXXTSCPS20**

### Compatibility of the power supply with the rack

The **BMXCPS...2S** is a safety-certified power supply that can be used as:

- a main local rack
- an extended local rack
- a main remote rack
- an extended remote rack

The **BMXCPS...2S** is a redundant power supply module. It can be installed alone in single power supply rack or dual power supply rack as a pair (master and slave)

For high-availability applications, two independent redundant power supplies can be used to increase the security of the power supply. In case the master power supply fails to provide the whole current, the slave power supply changes to master mode and continues to function.

The power supply module has to be inserted in the leftmost power supply slots on each rack (marked CPS).

### Advanced diagnostics

The **BMXCPS...2S** can provide advanced diagnostics such as current load, temperatures, remaining life time, and undervoltage thresholds. These unique values will help to simplify maintenance by predicting when to replace the power supply before it fails.

*Note: LED diagnostic display is provided for the module and for each input channel.*

### Functions

#### Alarm relay

The alarm relay incorporated in each power supply module has a volt-free contact accessible on the front panel, on the 2-way connector.

The operating principle is as follows:

- The alarm relay is energized and its contact is closed (state 1) in normal operation, with the PLC in RUN.
- The relay de-energizes and its associated contact opens (state 0) whenever the application stops, even partially, due to any of the following:
  - Occurrence of a blocking fault (RAM detected error in memory check, Safety watchdog overrun detected on CPU, etc.)
  - Incorrect rack output voltages
  - Loss of supply voltage

#### Reset pushbutton

The power supply module in each rack has a Reset button on the front panel.

Pressing the Reset button on the power supply causes re-initialization of all modules in the same rack as the power supply. If the **BMXCPS●●●2S** power supply module is in the main local rack, pressing the Reset button causes re-initialization of the CPU.

In a redundant design, with two **BMXCPS●●●2S** power supply modules, you can press the Reset button on either, or both, power supply modules to execute the reset function.

Pressing this pushbutton triggers a sequence of service signals, which is the same as that for:

- A power break, when the pushbutton is pressed.
- A power-up, when the pushbutton is released

In terms of the application, these operations represent a cold start (forcing the I/O modules to state 0 and initializing the processor).

### References

#### Safety power supply module (1)

Line supply	Available power (2)		Nominal current	Reference	Weight kg/lb
	3.3 V $\overline{\text{---}}$ (3)	24 V $\overline{\text{---}}$ rack (3)			
24...48 V $\overline{\text{---}}$	18 W	40 W	40 W	1.67 A	<b>BMXCPS4022S</b> 0.810/ 1.786
100...150 V $\sim$	180 W	40 W	40 W	1.67 A	<b>BMXCPS3522S</b> 0.610/ 1.345
100...240 V $\overline{\text{---}}$	18 W	40 W	40 W	1.67 A	<b>BMXCPS4002S</b> 0.510/ 1.124

#### Safety power supply module accessories

Description	Type	Composition	Reference	Weight kg/lb
Removable connectors	Spring-type	One 5-way terminal block and one 2-way terminal block	<b>BMXXTSCPS20</b>	0.015/ 0.033
	Caged	One 5-way terminal block and one 2-way terminal block	<b>BMXXTSCPS10</b>	0.020/ 0.044

(1) Include a set of 2 caged removable connectors. Spring-type connectors available separately under reference **BMXXTSCPS20**.

(2) The sum of the power consumed on each voltage (3.3 V  $\overline{\text{---}}$  and 24 V  $\overline{\text{---}}$ ) must not exceed the total power of the module. See the power consumption table available on our website [www.schneider-electric.com](http://www.schneider-electric.com).

(3) 3.3 V  $\overline{\text{---}}$  and 24 V  $\overline{\text{---}}$  rack voltages for powering modules in the Modicon X80 I/O rack.

M580\_62098\_SFSCT17005



Modicon M580 Safety configuration with a mix of standard X80 and Safety I/O

M580\_62098\_SFSCT17008



Modicon Safety configuration with Safety X80 modules only with removable terminal blocks

4

### Presentation of Safety I/O modules

X80 is a powerful, proven solution for integrating an homogeneous automation architecture with a unique process and safety platform.

In the Modicon X80 offer, a Safety project can include both Safety modules and non-safety modules:

- Safety modules in the SAFE task
- Non-safety modules only for the non-safety tasks (MAST, FAST, AUX0, and AUX1)

Only non-safety modules that do not interfere with the safety function can be added to a Safety project.

Safety I/O modules can be used to connect the Safety PAC to sensors and actuators that are not part of the safety function loop.

Each Safety I/O module incorporates a dedicated Safety processor.

Safety I/O modules can be installed in the local backplane or in RIO drops.

All Safety I/O modules support SIL3 standards according to IEC 61508. The assessment is indicated by the category (Cat) and performance level (PL).

Each Safety I/O module provides module and channel LED diagnostics on the front face of the module:

- The top four LEDs (Run, Err, I/O, and Lck) indicate the module status.
- The bottom rows of LEDs combine with the top four LEDs to indicate the state and health of each input or output channel.

### Presentation of Safety discrete I/O modules

There are three Safety discrete I/O modules in the Modicon X80 I/O offer:

- **BMXSDI1602** discrete input module
- **BMXSDO0802** discrete output module
- **BMXSRA0405** discrete relay output module

These modules can only be used with a Safety CPU.

#### BMXSDI1602

The **BMXSDI1602** Safety discrete input module has the following features:

- 16 Type 3 (1) inputs, in two groups of 8 non-isolated inputs
- 24 V  $\overline{\text{---}}$  nominal input voltage
- Achieves SIL3, Cat2/PLd assessment using 1 input channel and Cat4/PLe using 2 input channels
- Compatible with 2- or 3-wire proximity sensors
- Optional provision of two 24 V  $\overline{\text{---}}$  outputs (VS1 and VS2) for short-circuit to 24 V  $\overline{\text{---}}$  monitoring
- Monitoring of external 24 V  $\overline{\text{---}}$  sensor supply voltage

#### BMXSDO0802

The **BMXSDO0802** Safety discrete output module has the following features:

- 8 non-isolated 0.5 A outputs
- 24 V  $\overline{\text{---}}$  nominal output voltage
- Achieves SIL3, Cat4/PLe assessment
- Monitoring of the external pre-actuator power supply

#### BMXSRA0405

The **BMXSRA0405** Safety discrete relay output module has the following features:

- 4 relay outputs with 5 A current
- 24 V  $\overline{\text{---}}$  and 24...230 V  $\sim$  nominal output voltage (overvoltage category II)
- Achieves SIL2, Cat2/PLc assessment using 1 relay and SIL3, Cat4/PLe using 2 relays
- Support for 8 pre-defined application wiring configuration selections
- Configurable automatic self-test monitoring of the relay capacity to execute the commanded output state (depending on the selected application wiring configuration)
- Configurable module settings for fallback mode and fallback timeout (in ms)

(1) According to IEC61131-2 standard

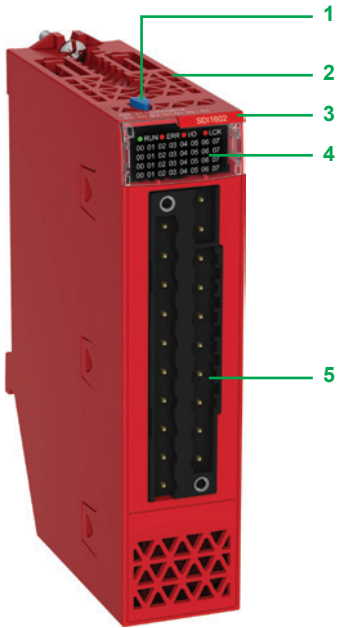

Safety discrete I/O module

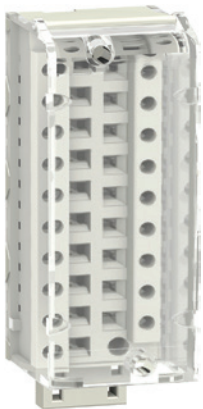

BMXFTB2000

### Description

Safety discrete I/O modules are standard format with one slot. They have an IP20 housing to help protect the electronics, and are locked into position with a captive screw.

To be ordered separately: A **BMXFTB2000** 20-way removable terminal block (identification label supplied with each I/O module) or a preassembled cordset with a 20-way removable terminal block at one end and flying leads at the other (see connections on [page 4/7](#)):

**BMXSDI1602**, **BMXSDO0802**, and **BMXSRA0405**, Safety discrete modules include:

- 1 Lock/unlock configuration button
- 2 Rigid body providing support and protection for the electronic card
- 3 Module reference marking (a label is also visible on the right-hand side of the module)
- 4 Display panel comprising LEDs with various combinations to provide quick diagnostics of the status of the module and each channel:
  - RUN LED (green): module in operation
  - ERR LED (red): detected module error
  - I/O LED (red): detected I/O error
  - LCK LED (bi-color green/red): indicates the configuration status
  - 1 LED per channel (bi-color green/red): indicates the channel status
- 5 Connector taking the 20-way removable terminal block for connecting sensors or preactuators

### Connections

20-way removable terminal blocks are used to connect the three Safety discrete I/O modules.

There are three types of 20-way removable terminal block:

- caged terminal block **BMXFTB2000** (1)
- screw clamp terminal block **BMXFTB2010** (1)
- spring-type terminal block **BMXFTB2020** (1)

Type of terminal block	Minimum capacity	Maximum capacity
Caged (1)	One 0.34 mm <sup>2</sup> wire (AWG 22)	One 1 mm <sup>2</sup> wire (AWG 18)
Screw clamp (1)	One or two 0.34 mm <sup>2</sup> wires (AWG 22)	Two 1.5 mm <sup>2</sup> wires (AWG 15)
Spring-type	One 0.34 mm <sup>2</sup> wire (AWG 22)	One 1 mm <sup>2</sup> wire (AWG 18)

(1) Connectors are equipped with captive screws: max. tightening torque 0.5 N.m/0.37 lb-ft.

**Note:** No cordset is provided for cabling Safety X80 I/O modules. Too many options are possible according to the kind of:

- application: safety only, safety mixed with availability, etc.
- functional safety level: SIL3/Cat2, SIL3/Cat4, SIL2, etc.

For more information on the different cabling options, please refer to the detailed user manuals published on our website: [www.schneider-electric.com](http://www.schneider-electric.com).

M580\_62098\_CPSCT16001D



BMXSDI1602

M580\_62098\_CPSCT16002A



BMXSDO0802

M580\_62098\_CPSCT16004A



BMXSRA0405

4

### References

#### Safety discrete input module

Type of current	Input voltage	Connection via	IEC/EN 61131-2 conformity	Number of channels (common)	Reference	Weight kg/lb
DC	24 V (logic positive)	Cage, screw, or spring-type 20-way removable terminal block	Type 3	16 non-isolated inputs (1 x 16)	<a href="#">BMXSDI1602</a>	0.115/ 0.254

#### Safety discrete output module

Type of current	Input voltage	Connection via	IEC/EN 61131-2 conformity	Number of channels (common)	Reference	Weight kg/lb
DC	24 V (logic positive)	Cage, screw, or spring-type 20-way removable terminal block	Yes	8 non-isolated outputs (1 x 8)	<a href="#">BMXSDO0802</a>	0.120/ 0.264

#### Safety relay output module

Type of current	Input voltage	Connection via	IEC/EN 61131-2 conformity	Number of channels (common)	Reference	Weight kg/lb
AC/DC relay	24 V $\overline{\text{---}}$ / 24...230 V $\sim$	Cage, screw, or spring-type 20-way removable terminal block	Yes	4 isolated outputs (1 x 4)	<a href="#">BMXSRA0405</a>	0.145/ 0.320

#### Removable terminal blocks

Description	For use with modules	Type composition	Reference	Weight kg/lb
20-way removable terminal blocks	BMXSDI1602	Caged	<a href="#">BMXFTB2000</a>	0.093/ 0.205
	BMXSDO0802	Screw clamp	<a href="#">BMXFTB2010</a>	0.075/ 0.165
	BMXSRA0405	Spring	<a href="#">BMXFTB2020</a>	0.062/ 0.132

M580\_62098\_CPSCT16001D

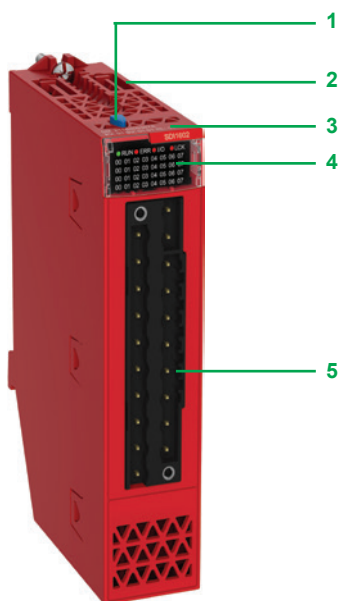

BMXSAI0410

M580\_62098\_OPEJFR17001A



SDI1602 red label

PF108141D

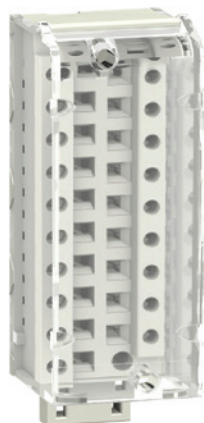

BMXFTB2000

### Presentation

The Safety analog input module in the Modicon X80 I/O offer is the **BMXSAI0410**. The **BMXSAI0410** Safety analog input module has the following features:

- 4 isolated analog 4...20 mA current input channels
- 16-bit resolution (12,500 counts), spanning the data range 0...25 mA
- Current out of range detection, for current values less than 3.75 mA or greater than 20.75 mA
- Achieves SIL3, Cat2/PLd assessment using 1 input channel and SIL3, Cat4/PLe using 2 input channels

This module can only be used with a Safety CPU.

### Description

The **BMXSAI0410** Safety analog input module includes:

- 1 Lock/unlock configuration button
- 2 Rigid body providing support and protection for the electronic card
- 3 Module reference marking (a label is also visible on the right-hand side of the module)
- 4 Display panel comprising LEDs with various combinations to provide quick diagnostics of the status of the module and each channel (1):
  - RUN LED (green): module in operation
  - ERR LED (red): detected module error
  - I/O LED (red): detected I/O error
  - LCK LED (bi-color green/red): indicates the configuration status
  - 1 LED per channel (bi-color green/red): indicates the channel status
- 5 Connector taking the 20-way removable terminal block for connecting sensors or preactuators

### Connections

20-way removable terminal blocks are used to connect the analog input module. (2)

There are three types of 20-way removable terminal block:

- caged terminal block **BMXFTB2000** (3)
- screw clamp terminal block **BMXFTB2010** (3)
- spring-type terminal block **BMXFTB2020**

Type of terminal block	Minimum capacity	Maximum capacity
Caged (3)	One 0.34 mm <sup>2</sup> wire (AWG 22)	One 1 mm <sup>2</sup> wire (AWG 18)
Screw clamp (3)	One or two 0.34 mm <sup>2</sup> wires (AWG 22)	Two 1.5 mm <sup>2</sup> wires (AWG 15)
Spring-type	One 0.34 mm <sup>2</sup> wire (AWG 22)	One 1 mm <sup>2</sup> wire (AWG 18)

Red labels are provided for Safety I/O modules.

### References

#### Safety analog input modules

Type of input	Input signal range	Resolution	Connection	Nb of channels	Reference	Weight kg/lb
Isolated high-level input	4–20 mA	16 bits	Removable terminal block, 20-way caged, screw clamp, or spring-type	4	<a href="#">BMXSAI0410</a>	0.143/ 0.315

#### Connection accessories for Safety analog input module

Description	For use with modules	Type composition	Reference	Weight kg/lb
20-way removable terminal blocks	BMXSAI0410	Caged	<a href="#">BMXFTB2000</a>	0.093/ 0.205
		Screw clamp	<a href="#">BMXFTB2010</a>	0.075/ 0.165
		Spring	<a href="#">BMXFTB2020</a>	0.060/ 0.132

(1) LEDs in positions 5...7 are not used because the input module only has four channels.

(2) No cordset is provided for cabling safety X80 I/O modules. Too many options are possible according to the kind of:

- applications: safety only, safety mixed with availability, etc.
- functional safety level: SIL3/Cat2, SIL3/Cat4, SIL2, etc.

For more information on the different cabling options, please refer to the detailed user manuals published on our website: [www.schneider-electric.com](http://www.schneider-electric.com).

(3) Connectors are equipped with captive screws: max. tightening torque 0.5 N.m/0.37 lb-ft.

# 5 - Communication and expert modules

## Drop adapters

- X80 CRA Ethernet drop adapters ..... [page 5/2](#)
- X80 NRP EIO drop fiber optic repeaters ..... [page 5/4](#)
- NOS Ethernet network option switch ..... [page 5/5](#)
- Peripheral remote I/O adapter ..... [page 5/6](#)

## Communication, integrated ports, and modules

*Selection guide* ..... [page 5/8](#)

### ■ X80 Modbus/TCP and EtherNet/IP network modules

- Presentation, functions, description ..... [page 5/10](#)
- FactoryCast, embedded router ..... [page 5/11](#)

### ■ X80 OPC UA module

- Presentation, description ..... [page 5/12](#)
- Architectures ..... [page 5/13](#)
- References ..... [page 5/15](#)

### ■ RTU communication

- Presentation, protocols ..... [page 5/16](#)
- Main functions ..... [page 5/17](#)

### ■ X80 RTU module

- Presentation, functions, description ..... [page 5/18](#)
- References ..... [page 5/19](#)

### ■ X80 Advanced RTU module

- Presentation, functions, description ..... [page 5/20](#)
- Architecture, references ..... [page 5/21](#)

### ■ X80 Ethernet Global Data service module

- Presentation ..... [page 5/22](#)
- Description, references ..... [page 5/23](#)

### ■ X80 AS-Interface module

- Presentation, description ..... [page 5/24](#)
- Diagnostics, references ..... [page 5/25](#)

### ■ X80 Modbus and Character mode serial links module

- Presentation, description ..... [page 5/26](#)
- Characteristics, references ..... [page 5/27](#)

### ■ X80 CANopen master module

- Presentation, description ..... [page 5/28](#)
- Diagnostics, references ..... [page 5/29](#)

### ■ X80 Profibus DP master module

- Presentation, description, architecture ..... [page 5/30](#)
- Software configuration, diagnostics, references ..... [page 5/31](#)

### ■ X80 IEC 61850 communication module

- Presentation ..... [page 5/32](#)
- Description, references ..... [page 5/33](#)

### ■ X80 Wi-Fi access point module

- Presentation, characteristics ..... [page 5/34](#)
- References ..... [page 5/35](#)



# Communication and expert modules

---

- **X80 GPS time server module**
  - Presentation ..... [page 5/36](#)
  - Diagnostics and wiring, characteristics, references ..... [page 5/37](#)
- **X80 weighing module**
  - Presentation, description ..... [page 5/38](#)
  - References ..... [page 5/39](#)
- **X80 diagnostic module**
  - Presentation, description ..... [page 5/40](#)
  - Operating modes, references ..... [page 5/41](#)
- **X80 Ethway module**
  - Presentation, description ..... [page 5/42](#)
  - Use cases, references ..... [page 5/43](#)

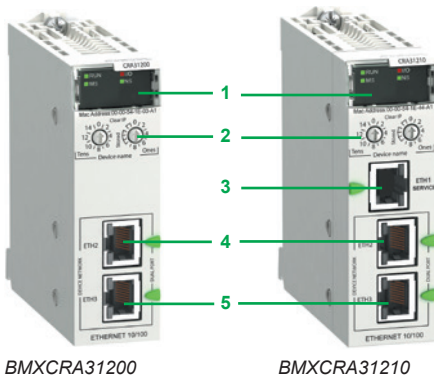

BMXCRA31200

BMXCRA31210

### Modicon X80 CRA Ethernet drop adapters (1)(2)

#### Presentation

A Quantum EIO architecture with Modicon X80 EIO drops requires the use of a dedicated CRA drop adapter in each Modicon X80 drop:

- “Standard” drop adapter **BMXCRA31200** (capacity, see below)
- “Performance” drop adapter **BMXCRA31210** (capacity, see below)

These drop adapters are connected by Ethernet cordsets equipped with RJ45 connectors. The dual Ethernet network connection port on each drop adapter allows daisy chain loop connections using the RSTP protocol (Rapid Spanning Tree Protocol).

Each module uses one slot in the Modicon X80 rack.

The **BMXCRA31210** adapter is also available in a conformal coating version for harsh environments.

#### Capacity of Quantum EIO architectures with Modicon X80 EIO

- 1 Quantum CPU drop that can have one primary rack and one secondary rack (3), equipped with a **140CPU6●●●●** advanced CPU
- With **140CPU651●●** standard CPUs and the **140CPU67160** HSBY CPU:
  - Up to 16 Modicon X80 EIO drops, limited to a maximum of 31 EIO drops (Quantum + Modicon X80)
- With the **140CPU65260** standard CPU and **140CPU6726●** HSBY CPUs:
  - Up to 31 Modicon X80 EIO drops, limited to a maximum of 31 EIO drops (Ethernet Quantum and Modicon X80)
- Each Modicon X80 EIO drop can comprise one primary rack and one secondary rack (3)
- Distance:
  - 100 m/328 ft between stations (copper medium)
  - 2 km/1.25 mi between Modicon X80 drops, with **BMXNRP0200** multimode fiber optic repeaters
  - 16 km/9.94 mi between Modicon X80 drops, with **BMXNRP0201** single-mode fiber optic repeaters

#### Description

- 1 Display block indicating the module status
- 2 Rotary switches for addressing EIO drops (00...159)
- 3 On **BMXCRA31210** module: dedicated RJ45 SERVICE port for remote service tools such as a PC, an HMI terminal, or Ethernet DIO devices (identical to the SERVICE port on Quantum CRP/CRA modules, see [page 2/6](#))
- 4 RJ45 DEVICE NETWORK port for connection to the Ethernet network
- 5 RJ45 DEVICE NETWORK port for connection to the Ethernet network

(1) For additional characteristics, see our website [www.schneider-electric.com](http://www.schneider-electric.com).

(2) Requires Unity Pro Extra Large software ≥ V7.0.

(3) Requires two **BMXXBE1000** rack expansion modules (one in the primary rack and one in the secondary rack) and a **BMXXBC●●●K** extension cable (0.8, 2, or 28 m/2.62, 6.56, or 92 ft) for connecting these two modules (see [page 2/8](#)).



BMECRA31210

### Modicon X80 performance EIO adapter

#### Presentation

An M580 Ethernet RIO (EIO) architecture with Modicon X80 I/O drops requires the use of a dedicated adapter in each Modicon X80 drop.

The **BMECRA31210** adapter supports Ethernet and X-bus communications across the remote backplane.

This EIO adapter module supports several expert modules such as counter and weighing modules and CCOTF (change configuration on the fly).

For Modicon X80 RIO drops on an Ethernet backplane, time-stamping can be managed with a resolution of 10 ms when using a **BMECRA31210** performance EIO adapter.

Only one **BMECRA31210** module can be installed per Modicon X80 RIO drop.

This module can also support a BMXXBP●●00 expansion rack.

The **BMECRA31210** adapter is designed to be installed on an Ethernet backplane in the main remote rack. The adapter supports the Modicon X80 I/O and partner modules with both Ethernet and X-bus connections (1).

The keying pin on the rear side of the module means the **BMECRA31210** adapter cannot be installed on unsupported backplanes.

These adapters are connected by Ethernet cordsets equipped with RJ45 connectors. The dual Ethernet connection port on each adapter allows daisy chain loop connections using the RSTP protocol (Rapid Spanning Tree Protocol).

The **BMECRA31210** adapter is also available in a conformal coating version for harsh environments.

### Capacity of the Modicon CRA drop adapter

Type of module	BMXCRA31200 "standard"	BMXCRA31210 "high performance"	BMECRA31210 "high performance"
Maximum number of racks per drop	Up to 2	Up to 2	Up to 2
SERVICE port	–	1	1
Discrete I/O modules	Up to 128	Up to 1024	Up to 1024
Analog I/O module	Up to 16	Up to 256	Up to 256
Expert modules supported:			
■ Serial link	–	<b>BMXNOM0200</b>	<b>BMXNOM0200</b>
■ Time- and date-stamping at 1 ms	–	<b>BMXERT1604T/H</b>	<b>BMXERT1604T/H</b>
■ Counter	–	<b>BMXEHC0200/ BMXEHC0800</b>	<b>BMXEHC0200/ BMXEHC0800</b>
■ Weighing	–	–	<b>PMESWT0100</b>
■ Frequency input	–	<b>BMXETM0200H</b>	<b>BMXETM0200H</b>
■ HART integrated analog I/O modules	–	–	<b>BMEAHI0812/ BMEAHO0412</b>
CCOTF function	–	Yes	Yes
Time- and date-stamping	–	10 ms	10 ms

### Description

- LED display block indicating the module status
- Rotary switches for setting the address of an EIO drop (00...159)
- Dedicated RJ45 service port (ETH 1) for remote service tools such as a PC, HMI terminal module, or Ethernet DIO devices
- RJ45 device network port (ETH 2) for connection to the Ethernet network
- RJ45 device network port (ETH 3) for connection to the Ethernet network

### References

#### Ethernet drop adapter

Description	SERVICE port	Reference	Weight kg/lb
<b>X80 EIO drop adapter</b> Provide one module per Modicon X80 EIO drop	1	<b>BMECRA31210</b>	–

(1) This module is also compatible with X-bus backplanes. In this case it has the same functionality as a **BMXCRA31210** performance Ethernet drop adapter. For more details, see our website [www.schneider-electric.com](http://www.schneider-electric.com).

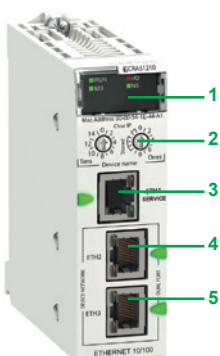

BMECRA31210

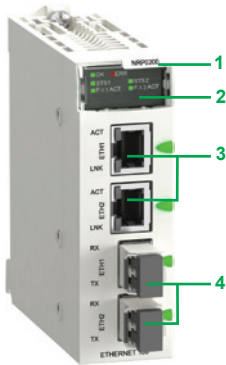

BMXNRP0200●

### Modicon X80 EIO drop fiber optic repeaters (1) (2)

#### Presentation

**BMXNRP0200/0201** fiber optic repeaters offer an alternative to the use of ConneXium managed dual ring switches (DRS), for fiber optic communications over long distances in Ethernet I/O systems.

When inserted in Modicon X80 EIO drops, **BMXNRP0200/0201** fiber optic repeaters make it possible to:

- Extend the total distance of the EIO network when EIO drops are located in areas of the factory more than 100 m/328 ft away
- Enhance immunity to noise
- Resolve grounding incompatibilities between sites with different grounding methods

NRP repeaters can be installed on the primary ring or on secondary rings. These modules cannot, however, be used to connect secondary rings to the primary ring. The **BMXNRP0200** repeater for multimode optical fiber allows remote location up to 2 km/1.25 mi.

The **BMXNRP0201** repeater for single-mode optical fiber allows remote location up to 16 km/9.94 mi.

Depending on the configuration, the NRP repeater may be linked to the CRA adapter of the drop where it is installed, via 1 or 2 Ethernet Interlink cables.

#### Description

- 1 Module reference
- 2 Display block indicating the module status
- 3 RJ45 Ethernet ports (2 LEDs, LNK and ACT, indicate the status of each port)
- 4 Fiber optic ports with SFP transceiver for LC type connector

### References (1)

#### X80 EIO drop fiber optic repeaters (2)

Description	Optical fiber	Reference	Weight kg/lb
Modicon X80 EIO drop fiber optic repeaters	Multimode	<a href="#">BMXNRP0200</a>	–
	Single-mode	<a href="#">BMXNRP0201</a>	–

(1) For additional characteristics, see our website [www.schneider-electric.com](http://www.schneider-electric.com).

(2) Requires Unity Pro Extra Large software ≥ V7.0: see our website [www.schneider-electric.com](http://www.schneider-electric.com).

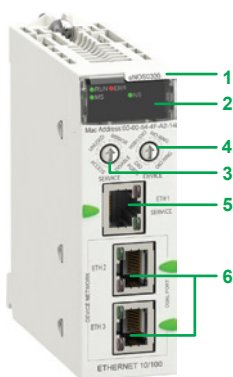

BMENOS0300

### Ethernet network option switch

#### Presentation

The **BMENOS0300** Ethernet network option switch offers an economic alternative to external DRSs for copper Ethernet communication over short distances. Based on the rotary switches on the front panel, the application of the 2 device network ports can be configured intuitively as:

- RIO ring
- DIO ring
- DIO ports

Depending on the architecture, the **BMENOS0300** switch can be used to communicate with the distributed I/O by simply inserting it in the local main rack or remote drops.

#### Description

- 1 Module reference
- 2 Display block indicating the module status
- 3 Rotary switch for configuring the ETH 1 service port
- 4 Rotary switch for configuring the 2 device network ports (ETH 2 and ETH 3)
- 5 ETH 1: Service port (Ethernet)
- 6 ETH 2/ ETH 3: Device network port (Ethernet)

### References (1)

#### Ethernet network option switch

Description	SERVICE port	Device network port (Ethernet)	Reference	Weight kg/lb
Ethernet network option switch	1	2	<a href="#">BMENOS0300</a>	–

(1) For additional characteristics, see our website [www.schneider-electric.com](http://www.schneider-electric.com).

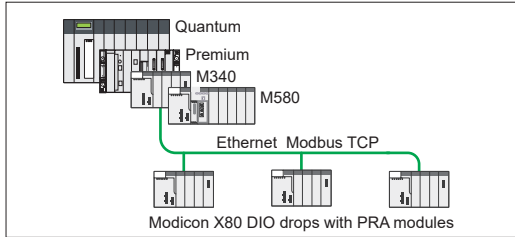

Modicon X80 DIO drops in a Quantum/Premium/M340/M580 I/O architecture using Ethernet Modbus TCP

### Presentation

The peripheral remote I/O adapter (PRA) is dedicated to Modicon X80 DIO drops in a Quantum/Premium/M340/M580 I/O architecture using Ethernet Modbus TCP.

The BMXPRA0100 module manages a remote X80 I/O rack on Ethernet Modbus TCP which includes:

- discrete I/O modules
- analog I/O modules

It communicates by I/O scanning with the master PAC (Quantum/ Premium/M340/ M580).

In case of a redundant Ethernet link, the use of a BMXNOE0100 Ethernet module is necessary.

### Principal characteristics

#### Primary racks per drop

Up to 4

#### Discrete I/O modules

Up to 1,024

#### Analog I/O modules

Up to 256

#### Internal memory

Up to 448 Kbits

#### Memory card capacity

Up to 96 Kbits

#### Average consumption

95 mA

#### Dissipated power

2.3 W

#### Real time clock with battery backup

Yes

### Description

- 1 Module reference
- 2 Display block indicating the module status
- 3 Memory card port with protective cover
- 4 RJ45 Ethernet port

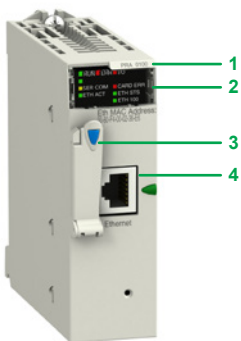



BMXPRA0100

Reference (1)		
Description	Reference	Weight kg/lb
Peripheral remote I/O adapter Provide 1 module per Ethernet Modbus TCP DIO drop	<a href="#">BMXPRA0100</a>	—

(1) Requires Unity Pro software ≥ V4.1.

# Modicon X80 modules platform

## Communication, integrated ports, and modules

Applications		RTU communication	
Type of device		RTU module	
			
Network protocols		Modbus/TCP, IEC 60870-5-104, DNP3 (subset level 3)	Serial link, external modem link, IEC 60870-5-101, DNP3 (subset level 3)
Structure		Physical interface Type of connector Access method Data rate	10BASE-T/100BASE-TX (Modbus/TCP), PPPoE (Point-to-Point Protocol over Ethernet) for ADSL external modem link One RJ45 connector CSMA-CD (Modbus/TCP), Master/slave (IEC 104/DNP3) 10/100 Mbps (Modbus/TCP)
Medium		Double twisted pair copper cable, category CAT 5E, optical fiber via ConneXium cabling system	Non-isolated RS 232/485 (serial link), non-isolated RS 232 (radio, PSTN, GSM, GPRS/3G external modem link) One RJ45 connector Master/slave (IEC101/DNP3) 0.3...38.4 Kbps (serial link)
Configuration		Maximum number of devices Maximum length Number of modules of the same type per station	Double shielded twisted pair copper cable, crossover serial cable (serial link), direct serial cable (external modem link) 32 max. 1,000 m/3,281 ft (serial link with insulating case) Depending on application-specific channels (20/64 application-specific channels with BMXP34/BMEP58)
Standard services		Modbus/TCP messaging	Reading/writing discrete and analog I/O, counters
Transparent Ready conformity class		C30	–
Embedded Web server services		Standard services Configurable services	–
Transparent Ready communication services		I/O Scanning Global Data NTP time synchronization FDR SMTP e-mail notification SOAP/XML web service SNMP network management RSTP redundancy QoS (Quality of Service)	–
RTU communication services		Master or Slave configuration Time- and date-stamped data exchange RTU time synchronization Management and buffering of time- and date-stamped events Automatic transfer of time- and date-stamped events to the Master/SCADA	Yes, IEC101/104 and DNP3 Interrogation via polling and exchanges on change of status (RBE), unsolicited messaging Yes, IEC101/104 and DNP3 Yes, IEC101/104 and DNP3 Yes, IEC101/104 and DNP3 Buffer holding 10,000 events (per connected client, 4 clients max.)
Data Logging service		Yes, on 128 MB SD memory card, in CSV files, access via FTP, or sent by e-mail	–
Compatibility with processor		Standard and Performance M340 processors All M580 processors	–
Processor or module references depending on other type of integrated port		–	–
Page		5/19	5/19

Applications		AS-Interface communication	Serial link communication	CANopen communication	IEC 61850 communication
Type of device		AS-Interface actuator/sensor bus module	2-channel serial link module	CANopen master module	IEC 61850 Ethernet module
					
Network protocols		AS-Interface	Modbus and Character mode	CANopen	Ethernet Modbus/TCP, IEC 61850
Structure		Physical interface Type of connector Access method Data rate	AS-Interface V3 standard 3-way SUB-D Master/slave 167 Kbps	Non-isolated RS 232, 8-wire Isolated RS 485, 2-wire 2 RJ45 and 1 RJ45 Twisted shielded pair copper cable 500 Kbps at 100 m/328 ft 1 Mbps at 20 m/65.62 ft	ISO 11898 (9-way SUB-D connector) Master/slave 9-way SUB-D Twisted shielded pair cable 3 RJ45 connectors (2 connectors for a ring topology) plus Ethernet backplane connection CSMA-CD 10/100 Mbps
Medium		2-wire AS-Interface cable	Shielded twisted pair copper cable	Twisted shielded pair cable	Double twisted pair copper cable, category CAT 5E
Configuration		Maximum number of devices Maximum length Number of links of the same type per station	62 slaves 100 m/328 ft, 500 m/1,640 ft max. with 2 repeaters BMXP341000 processor: 2 AS-Interface modules	2 per drop, 16 per Ethernet remote I/O (RIO) network max. 36 application-specific channels with BMXP341000/P342 (1 application-specific channel = 1 counter, motion control, or serial link module channel)	16 clients, 32 IED servers Up to 4 Ethernet modules per station depending on processor
Standard services		Transparent exchanges with the sensors/actuators	Read/write bits and words, diagnostics in Modbus mode Send and receive character string in Character mode	Transparent exchanges with CANopen slaves and Ethernet-based processors	IEC 61850 MMS Client, Server, GOOSE SNMP, RSTP, NTP Client
Conformity class		M4 profile	–	EDS description files of the slaves	–
SMT e-mail notification service		–	–	–	–
Compatibility with processor		Standard and Performance M340 processors All M580 processors	–	M580 standard processors	All M580 processors
Type of processor or module depending on other integrated port		None Serial link Ethernet Modbus/TCP	–	–	–
Page		5/25	5/28	5/28	5/32



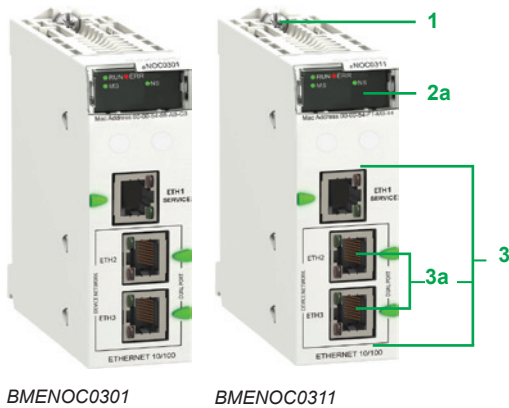

BMENOC0301

BMENOC0311

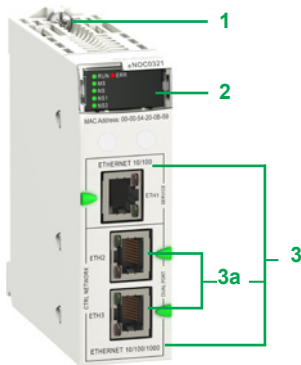

BMENOC0321

### Presentation

**BMENOC03●1** network modules act as an interface between the M580 PLC and other Ethernet network devices via the Modbus/TCP and EtherNet/IP communication protocols.

**BMENOC03●1** network modules are standard format and occupy a single slot in the rack of the Modicon M580 platform. They have to be installed in the main Ethernet + X-bus backplane rack.

### Functions

**BMENOC03●1** modules offer the following functions:

- Modbus/TCP and EtherNet/IP protocols operating simultaneously
- Ring topologies on 2 Ethernet ports using RSTP (Rapid Spanning Tree Protocol)
- Priority of Ethernet packets using QoS (Quality of Service) service
- Automatic module configuration recovery using FDR (Fast Device Replacement)
- Embedded Web server for application monitoring and module diagnostics (this is an HTML5 Web server, which means it can be read by any device (PC, tablet, smartphone) with the majority of operating systems (Android, iOS, Windows))
- Sharing data between PLCs ("local slaves" function)
- Network management using SNMP (Simple Network Management Protocol)

### Description

The front panel of **BMENOC03●1** modules features:

**1** A screw for locking the module in a slot in the rack

**2** A display block with 4 LEDs:

- RUN LED (green): Operating status
- ERR LED (red): Error detected
- MS LED (green/red): Module status
- NS LED (green/red): Network connection status

Additionally for **BMENOC0321** modules, 2 LEDs are displayed as:

- NS1 LED (green/red): Ethernet network status
- NS2 LED (green/red): Ethernet network status

**3** 3 RJ45 connectors for connection to the Ethernet network (the 2 bottom connectors **3a** support ring topologies (RSTP protocol))

Each RJ45 connector has 2 associated LEDs:

- LNK LED (yellow): Ethernet link established
- ACT LED (green): Transmission/reception activity



Example of BMEP58 and NOC module combination:  
BMEP581020/BMENOC0301/BMENOC0301

### FactoryCast

**BMENOC0311/BMENOC0321** FactoryCast modules provide additional web-based visualization of ePAC diagnostics and system data, such as:

- Custom web pages: allow the user to define a personalized interface
- Rack Viewer: provides a graphical representation of the configured ePAC system including all modules and I/O status
- ePAC Program Viewer: provides a web-based view of the EcoStruxure Control Expert (1) program code that animates logical states and variable values
- Customizable dashboard: allows a customized widget to be added to provide an optimum overview of the process data
- Trend Viewer: provides a graphical visualization of the variables
- Easy brand labeling: the website logo and colors can be adjusted online

### Embedded router

The **BMENOC0321** embedded router provides bridge transparency from the control network to the device network and connectivity with functions such as:

- Embedded IP forwarding: enables communication from the control network to PACs, PLCs, PCs, HMIs, etc.
- IPsec feature: applicable when the IP forwarding function is disabled
- Time synchronization: to be able to synchronize with external time servers and update the internal clock
- SMTP (Email): to send messages and alerts about the ePAC system
- Embedded switch in the M580 platform: provides a direct connection to the processor without any cable, and no separate power supply is required
- Fast Device Replacement service
- Multiple diagnostics: supports advanced web pages to FactoryCast, MB Diagnostics, EIP Diagnostics, CNM (ConneXium Network Manager)

### Combination of Ethernet modules and BMEP58 CPU

It is possible to combine Ethernet modules with the Modicon M580 CPU in order to increase its connectivity (2).

In this example, the 3 NOC EtherNet/IP, Modbus/TCP network modules 2 are linked to the BMEP581020 CPU module 1:

- 1 **BMEP581020** CPU
- 2 **BMENOC0301** EtherNet/IP, Modbus/TCP network module

(1) EcoStruxure Control Expert software continues the Unity Pro range of software and corresponds to versions  $\geq 14$  of Unity Pro.

(2) For each M580 processor, up to 2 **BMENOC0321** modules can be integrated in the same rack.



### Presentation

The **BMENUA0100** OPC UA module is an Ethernet communications module with an embedded OPC UA server for communication with OPC UA clients, including SCADA. It brings high-performance OPC UA capabilities to Modicon M580 ePAC systems via the Modicon X80 I/O platform.

OPC UA (Open Platform Communications Unified Architecture) is a modern, secure, open, reliable standard for industrial communications. It defines a common infrastructure model to facilitate information exchange for industrial processes, including information context via meta-data, helping to ensure open interoperability, eliminating engineering repetition, simplifying system configuration, and reducing maintenance overhead.

### Description

- 1 LED array
- 2 Control port with Ethernet link and activity LEDs
- 3 Ethernet backplane port
- 4 X-bus backplane port
- 5 Cybersecurity mode rotary switch. The three switch positions are:
  - Secured
  - Standard
  - Security reset

The **BMENUA0100** module can be installed in any X80 Ethernet backplane slot in the head rack of a Modicon M580 ePAC system.

### Features

The OPC UA module is available in two designs:

- **BMENUA0100** for standard environments
- **BMENUA0100H** for harsh environments

The module includes the following features:

- **Cybersecurity:** Improved security by design features including encrypted firmware, network isolation, IPSEC integration, and full implementation of OPC UA cybersecurity features.
- **Scalable performance:** The module is designed to provide scalable performance from low bandwidth IIoT connectivity through to highly demanding operational SCADA connections with thousands of monitored variables without impacting M580 CPU scan rate.
- **Simplified engineering:** Integrated access to M580 ePAC data dictionary including simple or structured data types, online variable changes with no break in system communications and advanced, predefined diagnostic information.

### OPC UA services

- Server Stack services (read/write, browse, call, publish, etc.)
- Server Stack Data Access Services
  - Data Access Server Facet
  - ComplexType 2017 Server Facet
  - Core 2017 Server Facet
- Server Stack Discovery and Security Services
- Server Stack Publish and Subscribe Services
- Server Stack Transport Services

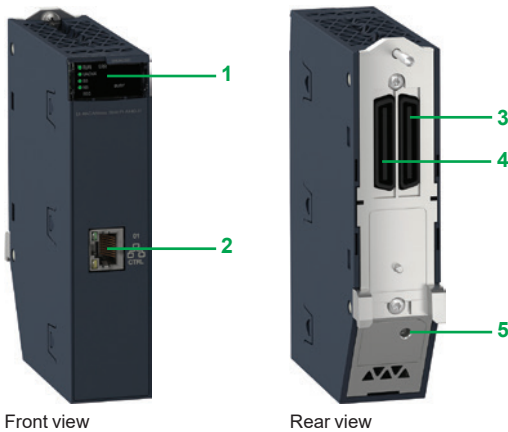

Front view

BMENUA0100

Rear view

### Example architectures

Flat network with multiple M580 Standalone CPUs and single SCADA

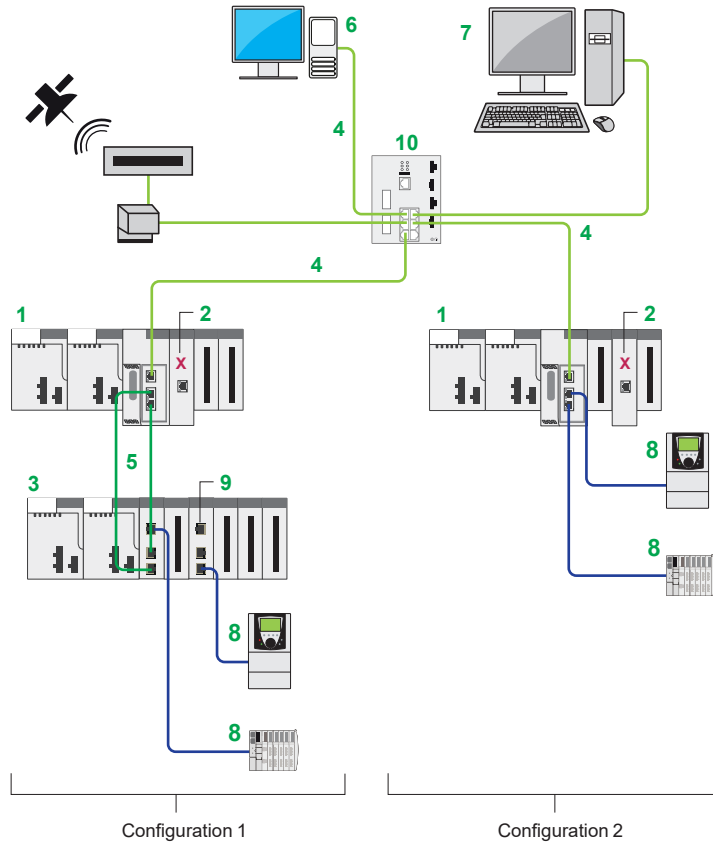

- 1 Standalone PAC
- 2 BMENUA0100 with control port disabled
- 3 X80 Ethernet RIO drop
- 4 Control network
- 5 Ethernet RIO main ring
- 6 OPC UA client (SCADA system)
- 7 Engineering workstation with single Ethernet connection
- 8 Distributed equipment
- 9 BMENOS0300 switch
- 10 Dual ring switch (DRS)

**Example architectures (continued)**

**Isolated control network with M580 Hot Standby PACs**

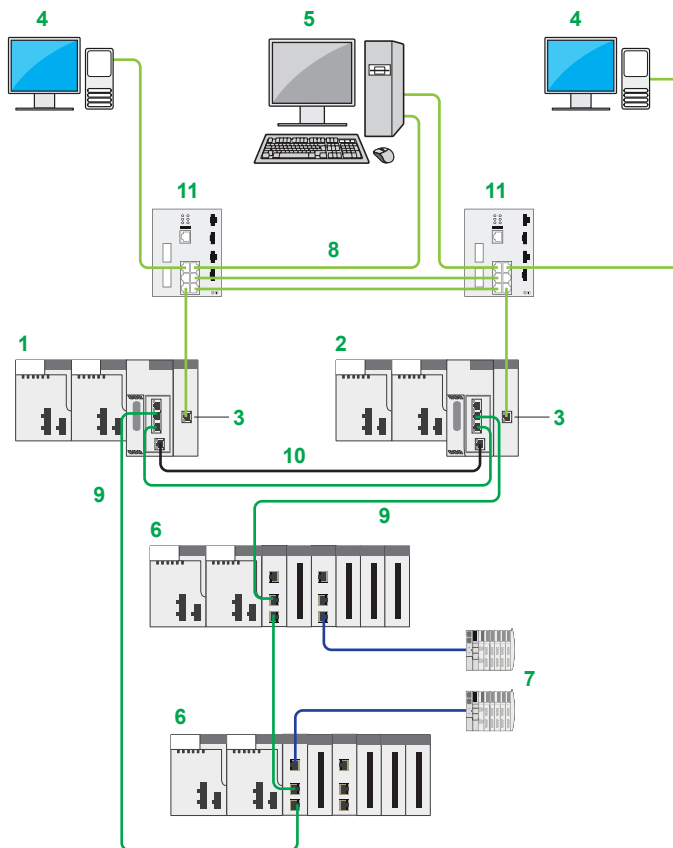

- 1 Primary Hot Standby PAC
- 2 Standby Hot Standby PAC
- 3 BMENUA0100 Ethernet communications module with embedded OPC UA server
- 4 OPC UA client (SCADA system)
- 5 Engineering workstation with dual Ethernet connections
- 6 X80 Ethernet RIO drop
- 7 Distributed equipment
- 8 Control network
- 9 Ethernet RIO main ring
- 10 Hot Standby communication link
- 11 Dual ring switch (DRS)

### Example architectures (continued)

Hierarchical network with multiple M580 Hot Standby CPUs and redundant SCADA connections

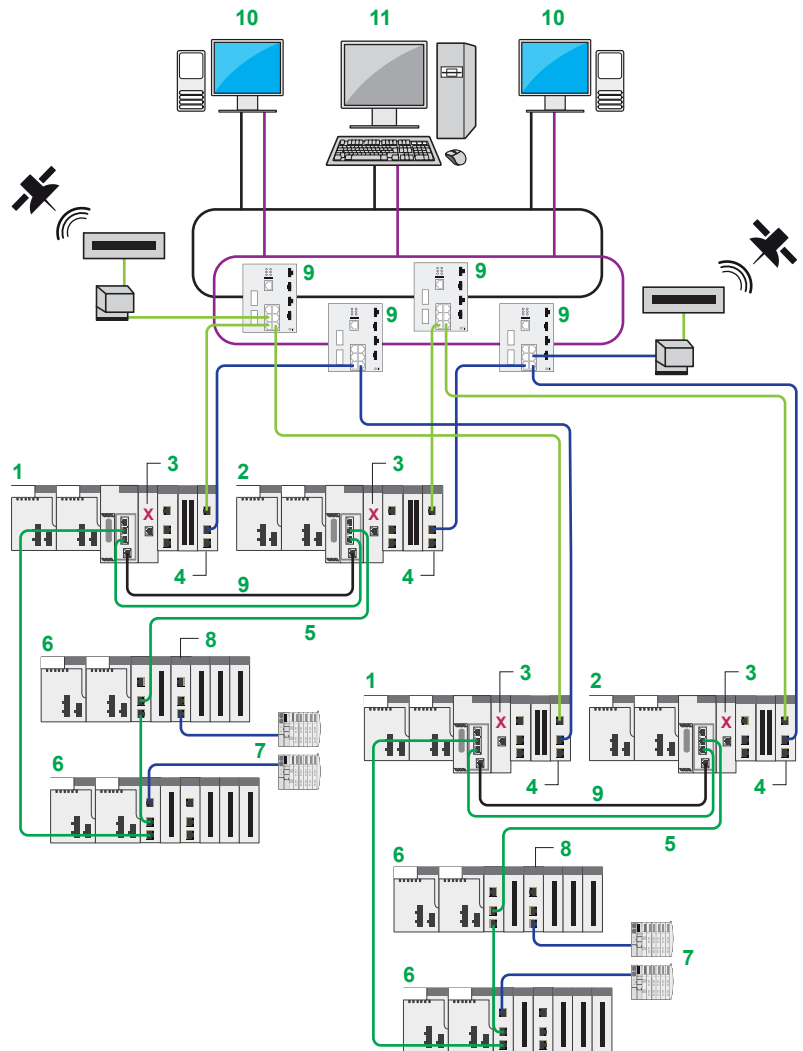

- 1 Primary Hot Standby PAC
- 2 Standby Hot Standby PAC
- 3 BMENUA0100 with control port disabled
- 4 BMENOC0321 Ethernet communications module
- 5 Ethernet RIO main ring
- 6 X80 Ethernet RIO drop
- 7 Distributed equipment
- 8 BMENOS0300 switch
- 9 Dual ring switch (DRS)
- 10 OPC UA client (SCADA system)
- 11 Engineering workstation with dual Ethernet connections

### References

#### X80 OPC UA module

Description	Reference	Weight kg/lb
OPC UA module for standard environments	<a href="#">BMENUA0100</a>	0.384/ 0.847
OPC UA module for harsh environments	<a href="#">BMENUA0100H</a>	0.384/ 0.847

### Presentation

RTU protocols and Telemetry systems provide a robust means of communication suitable for the process values, maintenance, and remote monitoring needs of infrastructures disseminated over a vast geographical area that may be difficult to access.

RTU systems are designed to meet the needs of the water industry, the oil and gas sector, and other infrastructures, where remote monitoring and telecontrol are essential to the effective management of sites and substations spread over a wide geographical area.

An RTU system consists of the following elements:

- A Telemetry Supervisor (SCADA) in a central control room
- A network infrastructure and a variety of suitable communication methods (LAN, WAN, modems, etc.)
- A large number of RTU substations geographically distributed throughout the field

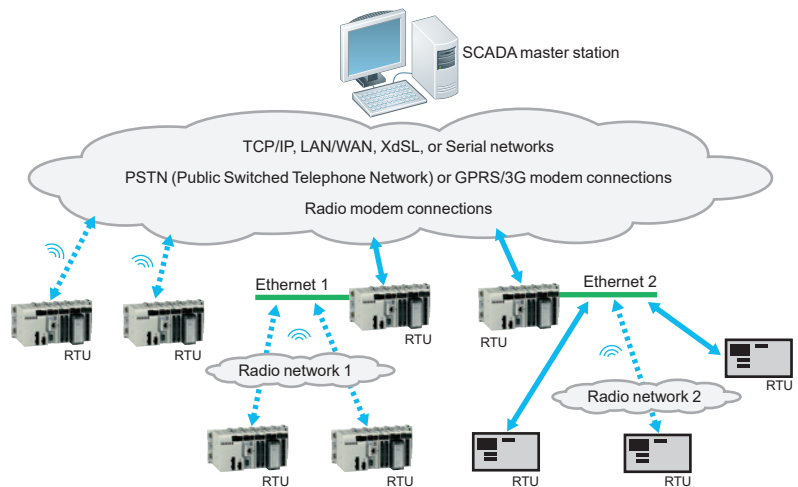

Example of an RTU system architecture

### RTU communication protocols

Currently, people working in the industrial Telemetry sectors use standard protocols for communication between control centers (SCADA) and RTU stations.

The most commonly used protocols are as follows:

- IEC 60870-5: IEC (International Electrotechnical Commission), in particular IEC 60870-5-101/104 (commonly known as IEC 101 or 104)
- DNP3: Distributed Network Protocol version 3

DNP3 is the predominant protocol in North America, Australia, and South Africa whereas, in certain European countries, the IEC protocol is required by law. IEC is also commonly used in the Middle East.

The geographical distribution of these protocols is as follows:

- DNP3: North America, Australia, New Zealand, UK, Asia, South America, etc.
- IEC 60870-5: Europe, Middle East, Asia, South America, etc.

These protocols offer similar functions.

They are both particularly suited to “transient communications” (modem, radio) and data exchanges with limited bandwidth for the following reasons:

- They transfer data in a very robust manner between the SCADA system and the RTU devices
- They are essentially “event-triggered” protocols (exchanges on changes of state, exchanges of time- and date-stamped events).

They offer the following transmission modes:

- Interrogation via polling
- Data exchanges on changes of state (RBE: report by exception)
- Unsolicited messaging (a slave station can start an exchange of data with the master station)

Both protocols offer native data management and time- and date-stamped events:

- Time synchronization between the master station and auxiliary stations via protocol functions
- Time- and date-stamping of data and events
- Automatic transfer of time- and date-stamped events between the RTU stations and SCADA (control room)

### Main functions

The main RTU system functions are as follows:

- Remote communications:
  - Between remote RTU sites (coordination, synchronization)
  - With the SCADA host system, controlling the central operator station (monitoring, alarm reports) and centralized databases (archiving of alarms or events)
  - With the on-call staff (alarm indication)
  - With the technical station (diagnostics, maintenance)
  
- Data acquisition, processing, and memorization:
  - Process data sampling using standard or dedicated sensors, validation
  - Exchange of data with other devices within the station, including controllers and operator consoles
  - Use of discrete or analog I/O, serial links, fieldbuses, and LANs
  - Event detection, time- and date-stamping, prioritization, and logging as required by the application
  
- Other functions:
  - IEC 1131-3 programmable control: forcing, access control, load sharing, servo control
  - Data logging
  - Alarm and report notification by e-mail/SMS
  - Web HMI: displaying the process, alarm handling, trend analysis, telecontrol
  - High reliability with hardened and ATEX range
  
- Advanced RTU systems also feature (see [page 5/20](#)):
  - Cybersecurity functions
  - Simplified architecture (one single controller to manage both process and RTU)
  - Integrating RTU DTM in Control Expert for easier configuration

Two RTU communication modules are included in Schneider Electric offer with the following characteristics :

Features	BMENOR2200H Step 1	BMXNOR0200H
<b>Platform support</b>	M580	M340, M580
<b>RTU protocol (1)</b>	DNP3 NET	DNP3, DNP3 NET, IEC60870-5-101, IEC60870-5-104
<b>Ethernet protocol (1)</b>	SNMP, SNTP, Modbus TCP, HTTPS	SNMP, SNTP, Modbus TCP, SMTP, FTP, HTTP
<b>Firmware upgrade tool</b>	Automation Device Maintenance	Unity loader
<b>Cyber secure</b>	Enhanced	Standard
<b>Web diagnostics</b>	Enhanced diagnostics	Standard diagnostics
<b>Safety system support</b>	Non-interfering Type 1 (1)	Not supported
<b>Data logging (1)</b>	No	Yes
<b>Serial port (1)</b>	No	Yes
<b>IP address assignment</b>	Static IP	DHCP, BootP, Static IP
<b>SD card availability (2)</b>	Optional	Mandatory
<b>Event buffer size</b>	150,000 + 40,000 (3)	100,000
<b>Maximum input data</b>	8,000 bytes	7,000 points
<b>Maximum output data</b>	8,000 bytes	7,000 points
<b>Data attribution</b>	Unlocated (4)	Located/Unlocated
<b>Strings exchange in DNP3</b>	Supported	No
<b>DNP3 SA key method</b>	Pre-shared key	No
<b>DNP3 secure statistics</b>	Yes	No

(1) The BMENOR step 1 module will be improved later to step 2 to include more functions than the BMXNOR. The step 1 to step 2 update will be achieved by upgrading the firmware and DTM.

(2) The SD card is only used for the data logging feature (step 2).

(3) 40,000 event buffer used for DNP3 SAV5 security statistics events.

(4) When the user selects "On-Demand" mode for AO/BO point in DNP3 outstation, the value will be generated as a located variable.



### Presentation

The **BMXNOR0200H** communication module integrates the RTU (remote terminal unit) functions and protocols in the Modicon X80 I/O platform for industrial telemetry applications and other widely distributed infrastructures.

The **BMXNOR0200H** module can be used to connect an RTU X80 I/O PLC directly to a telemetry supervisor or to other RTU stations, via the standard DPN3 protocols (subset level 3) or IEC 60870-5-101/104 with different connection methods: Ethernet TCP/IP, LAN, WAN, serial link, or modem connections (radio, PSTN, GSM, GPRS/3G, ADSL).

The **BMXNOR0200H** module is designed to operate in a harsh environment (conformal coating), in an extended temperature range (-25 to +70 °C/-13 to +158 °F).

### Functions

The **BMXNOR0200H** module offers the following functions:

- Upstream RTU communication to the SCADA (server or slave mode)
  - Downstream RTU communication to field devices (master mode)
  - RTU protocols: Time synchronization, exchanges of time- and date-stamped data via polling (on change of state and unsolicited), management of time- and date-stamped events
  - Application data logging with time- and date-stamping in the module Flash memory card
  - Event notifications via e-mail or SMS
  - Embedded Web server for setting the RTU protocol parameters, diagnostics, and monitoring
- 
- Communications on Ethernet port:
    - 10BASE-T/100BASE-TX physical interface
    - Modbus/TCP protocol (client and server)
    - Integrated RTU protocols for Ethernet communications: DNP3 IP (client or server) and IEC 60870-5-104 (over IP) (client or server)
    - Connection of ADSL external modem on the Ethernet port, via the PPPoE (Point-to-Point Protocol over Ethernet) protocol
    - Advanced Ethernet functions: NTP client, FTP client or server, HTTP server, SOAP/XML server, SNMP agent, SMTP agent
  - Communications on serial port:
    - Isolated RS232/RS485 point-to-point serial links
    - Integrated RTU protocols for serial and modem communications: IEC 60870-5-101 (master or slave) and DNP3 serial (master or slave)
    - Connection of external modems (radio, PSTN, GSM, GPRS/3G) via the PPP (Point-to-Point Protocol) protocol

### Description

The **BMXNOR0200H** module can be installed in either a standard or “ruggedized” configuration, equipped with a standard **BMXP34●●●●●/BMEP58●●●●●** or “ruggedized” **BMXP34●●●●●H/BMEP58●●●●●H** processor.

The front panel of the **BMXNOR0200H** module features:

- 1 A screw for locking the module in a slot in the rack
- 2 A display block with 8 LEDs, 4 of which relate to the serial and Ethernet communication ports
- 3 A slot for a Flash memory card (SD card), with protective cover
- 4 An RJ45 connector for connection to the Ethernet network
- 5 An RJ45 connector for connection of the serial link or an external modem

**On the rear panel**, 2 rotary switches for selecting the IP address assignment method for the module.

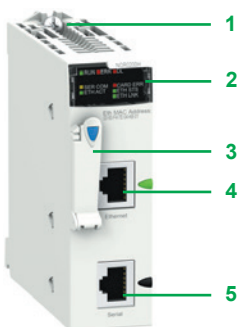



BMXNOR0200H

### References

Description	Communication port	Protocol	Reference	Weight kg/lb
X80 RTU communication module (1)	Ethernet 10BASE- 100BASE-TX	<ul style="list-style-type: none"> <li>■ Modbus/TCP (client or server), Transparent Ready class C30</li> <li>■ DNP3 IP (client or server)</li> <li>■ IEC 60870-5-104 (over IP) (client or server)</li> </ul>	BMXNOR0200H (2)	0.205/ 0.452
		Serial, External modems <ul style="list-style-type: none"> <li>■ Isolated RS232/RS485 point-to-point serial links</li> <li>■ DNP3 serial (master or slave)</li> <li>■ IEC 60870-5-101 (master or slave)</li> </ul>		

### Spare parts

Description	Usage	Supplied with module	Reference	Weight kg/lb
128 MB Flash memory card supplied as standard with the module	Web pages, storage of data logging files (CSV)	BMXNOR0200H	BMXRWS128MWF	0.002/ 0.004

(1) See ruggedized module characteristics, [page 6/2](#).

(2) The Web Designer software is supplied on CD-ROM with the module. This software can be used to configure and download the embedded website and to configure advanced services: data logging, sending alarm notifications via SMS or e-mail. For further information, please consult our website [www.schneider-electric.com](http://www.schneider-electric.com).

### Presentation

The **BMENOR2200H** Advanced RTU module is a communication module fully based on the Schneider Electric Ethernet backbone to address advanced use cases and complex configurations and reach new levels of architecture connectivity and simplicity:

- Optimum level of cybersecurity is reached from RTU protocol (DNP3 secure) to global Schneider architecture (RBAC).
- Configuration, operating mode, and diagnostics are fully integrated inside EcoStruxure Control Expert. Cybersecurity settings are configured on embedded web page based on HTTPS.

The **BMENOR2200H** module is designed to operate in large infrastructures such as pipelines, power generation plants, and transportation. It supports harsh environments (extended temperature range: -25 to +70 °C/-13 to +158 °F).

### Functions

**BMENOR2200H** features the following key functions:

- DNP3 Net SAV2/5 by pre-shared key, Server/Client
- System log for cybersecurity
- Time synchronized by CPU or RTU protocol
- Web page (HTTPS) for diagnostics and cybersecurity setting
- SNTP Client
- SNMP Agent
- RBAC Management
- Secure firmware download
- Sequence of Events (SOE)
- Modbus TCP Client/Server
- Other enhanced cybersecurity functions:
  - Enhanced password policy and login policy
  - System hardening, server services can be disabled/enabled
  - Rotary switch for selecting secure mode/standard mode
  - Secure boot

### Description

**BMENOR2200H** is installed on an Ethernet rack only (supports up to 4 Advanced RTU modules per CPU, based on different CPU levels).

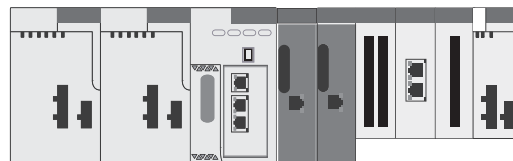

Front view

BMENOR2200H

Rear view

The front panel of the **BMENOR2200H** module presents:

- 1 A screw for locking the module in a slot in the rack
- 2 A display block with 7 LEDs (hardware diagnostic information: RUN, detected error, download firmware, serial data status, detected SD Card error, Ethernet communication status, cybersecurity status)
- 3 A slot for a Flash memory card (4 GB SD card), with green protective cover (1)
- 4 A RJ45 serial port supporting RS485 and RS232 (2)

The back panel of the **BMENOR2200H** module features:

- 5 A rotary switch for cybersecurity (Secure mode, Standard mode and Reset) (a dedicated screwdriver is shipped in the box from factory)
- 6 A dual port for X-bus and Ethernet communication

(1) SD Card is only used for data logging feature, not implemented yet.

(2) Not implemented yet; dust cover is provided.



### Architecture

#### Example of architecture: Single network

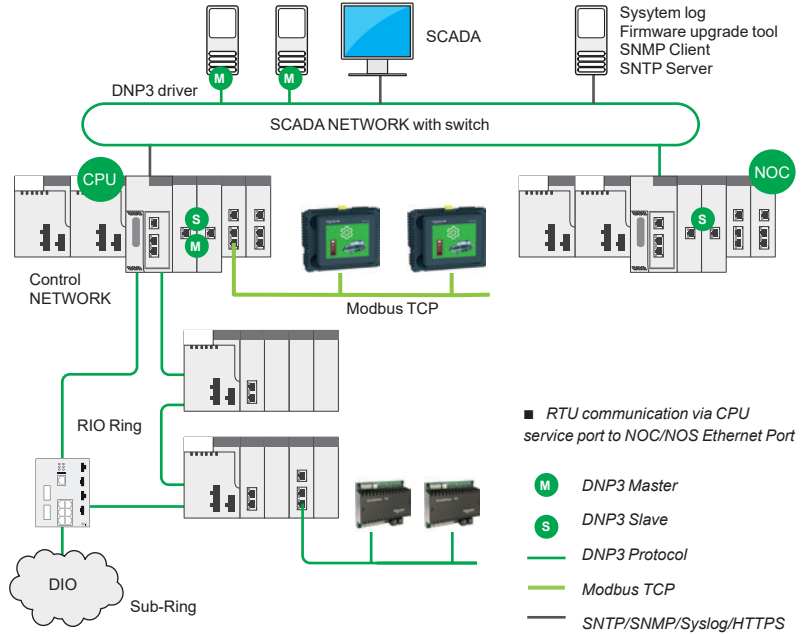

#### Example of architecture: Isolated network

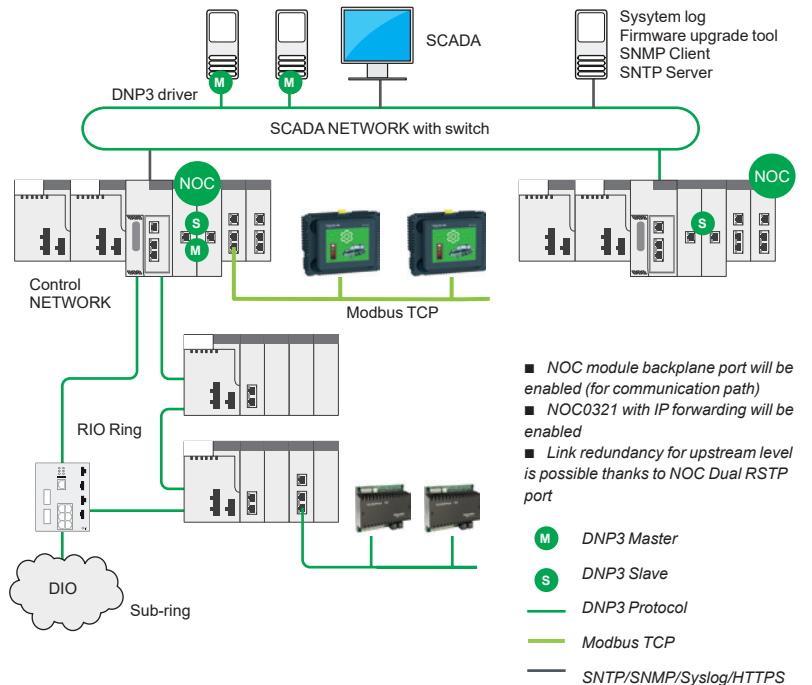

### References

Description	Communication port	Protocol	Reference	Weight kg/lb
X80 Advanced RTU module, Ethernet-based, 1 serial port, hardened (1)	Ethernet	DNP3 SAV2/SAV5, Modbus TCP, SNMP, HTTPS, SNTP	<a href="#">BMENOR2200H</a>	0.380/ 0.837

(1) See ruggedized module characteristics, [page 6/2](#).

### Presentation

#### Global Data service

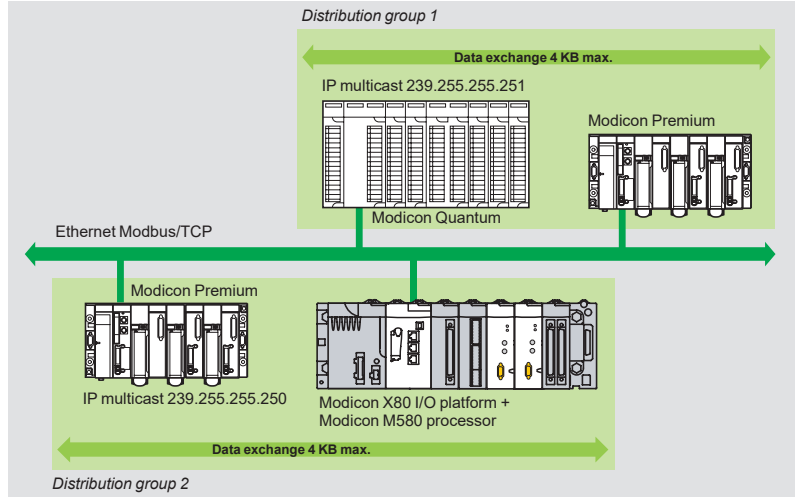

The Global Data service performs data exchanges in real time between stations belonging to the same distribution group. It is used to synchronize remote applications, or to share a common database between a number of distributed applications. Exchanges are based on a standard producer/consumer protocol, helping to ensure optimum performance with a minimum load on the network. This RTPS (Real Time Publisher Subscriber) protocol is promoted by Modbus-IDA (Interface for Distributed Automation), and is already a standard adopted by several manufacturers.

#### Characteristics

A maximum of 64 stations can participate in Global Data within a single distribution group. Each station can:

- Publish one 1024-byte variable. The publication rate can be configured between 10 ms and 1,500 ms in increments of 10 ms.
- Subscribe to between 1 and 64 variables. The validity of each variable is controlled by health status bits linked to a refresh timeout configurable between 50 ms and 15 s. Access to an element of the variable is not possible. The total size of subscribed variables amounts to 4 K contiguous bytes.

To further optimize the performance of the Ethernet network, Global Data can be configured with the “multicast filtering” option which, together with switches in the ConneXium range, broadcasts data only to Ethernet ports where there is a Global Data service subscriber station. If these switches are not used, Global Data is sent in “multicast” mode to all switch ports.

#### Global Data service diagnostics

The diagnostic screens use a color code to show the Global Data status:

- Configured/not configured/detected fault
- Published/subscribed

Global Data service diagnostics can be performed in one of four ways:

- Via the application program from a specific PLC data zone
- From the setup software debug screen
- From the PLC system diagnostic function displayed by means of a Web browser on a PC station
- Using standard SNMP manager software

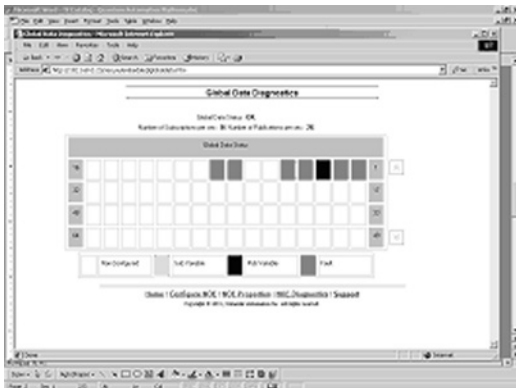

Global Data diagnostics

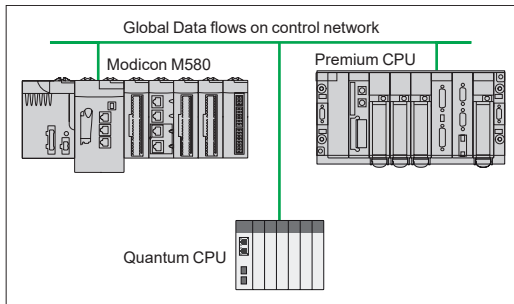

Example of architecture to implement BMXNGD0100



BMXNGD0100

### Description

#### BMXNGD0100

The **BMXNGD0100** Ethernet Global Data module is specifically designed to modernize the large and complex Modicon installed base (mainly Premium and Quantum) by running the Global Data service more easily.

In addition to the Global Data service, the **BMXNGD0100** module also has the following embedded services, as it can also be used for inter-controller communication to provide solutions for complex processing and high-end applications:

- Ipconfig
- Modbus TCP explicit messaging (client and server)

Designed as a neat solution specifically for the Global Data service, some services, such as IO-Scanner, Web, FDR, and NTP, are not supported by the **BMXNGD0100** module. This module is only compatible with **BMEXBP●●●●** Ethernet racks in standalone architectures on the X80 platform, to keep the global data transferring internally only, isolated from the external world to help ensure a strict level of cybersecurity.

If these functions are required, please check with our Customer Care Center for alternative products that can fulfill these needs.

### References

Description	Use	Reference	Weight kg/lb
<b>X80 Ethernet Global Data module</b> supplied Flash memory card (BMXRWSC016M)	Inter-controller communication service to transfer global data between each controller for complex multi-controller architectures	<a href="#">BMXNGD0100</a>	0.200/ 0.440
<b>Flash memory card</b>	Store global data for applications	<a href="#">BMXRWSC016M</a>	0.002/ 0.004

### Presentation

The **BMXEIA0100** master module for AS-Interface cabling system provides the AS-Interface system master function for the Modicon X80 I/O platform.

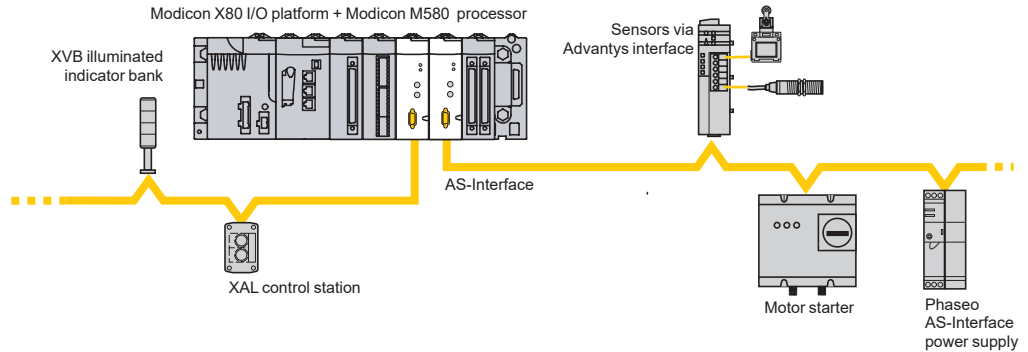

The AS-Interface cabling system consists of a master station (Modicon X80 I/O platform) and slave stations. The master supporting the AS-Interface profile interrogates the devices connected on the AS-Interface line one-by-one and stores the information (actuator/sensor status, device operating status) in the PLC memory. Communication on the AS-Interface line is managed totally transparently in relation to the application PLC program.

The **BMXEIA0100** master module supports the latest management profile for AS-Interface devices (*AS-Interface V3*), which is able to manage level V1, V2, and V3 AS-Interface slaves:

- Discrete slave devices (up to 62 devices of 4 inputs/4 outputs organized in 2 banks (A/B) of 31 addresses each)
- Analog devices (up to 31 devices (4 channels) in bank A)
- Safety interfaces (up to 31 devices in bank A)

An AS-Interface power supply is essential for powering the various devices on the line. Ideally it should be placed near stations that consume a great deal of energy. Please refer to the "Phaseo power supplies and transformers - AS-Interface range" catalog.

A Modicon M340 Performance configuration with a **BMXP3420●0/20●02** processor or a Modicon M580 configuration with a **BMEP58●●●●** processor can take 4 **BMXEIA0100** modules. A Standard configuration with **BMXP341000** processor can take 2 **BMXEIA0100** modules.

### Description

The **BMXEIA0100** AS-Interface master module is standard format (1 slot). Its housing provides IP20 protection of the electronics and it is locked into each rack slot (**01** ... **11**) by a captive screw.

The front panel of the **BMXEIA0100** AS-Interface master module features:

- 1 A rigid body providing support and protection for the electronic card
- 2 A module reference marking
- 3 A display block with 5 LEDs indicating the module operating modes:
  - RUN (green): Module running
  - ERR (red): Detected module fault
  - A/B (green): Displays the group of 31 slaves
  - I/O (red): Detected I/O fault on AS-Interface line
  - 32 LEDs for diagnostics of the AS-Interface line and each slave connected on the line depending on the A/B pushbutton selection (1)
- 4 2 LEDs marked ASI POWER and FAULT: AS-Interface external power supply present and detected AS-Interface line fault (see diagnostics on [page 5/25](#))
- 5 Two pushbuttons marked A/B and MODE (see diagnostics on [page 5/25](#))
- 6 A 3-way male SUB-D connector for the AS-Interface cable (female screw connector supplied)

(1) Depending on whether A or B is selected, this displays either the first 31 slaves (standard addressing) or the last 31 slaves (extended addressing).

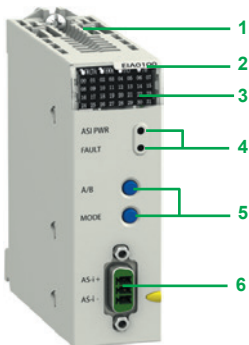

BMXEIA0100

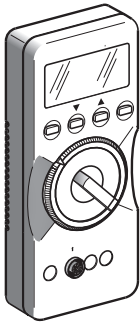
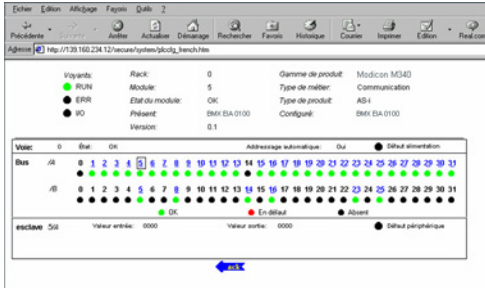

ASITERV2

### Diagnostics

#### BMXEIA0100 module

The two LEDs **4** on the module front panel are used in conjunction with the two pushbuttons **5** for module diagnostics:

#### LEDs

**4** ASI PWR: AS-Interface power supply present

#### Pushbuttons

**4** FAULT: Detected AS-Interface line fault

**5** A/B: Selects the group of slaves on the display block **3**

**5** MODE: Module Offline/Online

The display block on the front panel of the **BMXEIA0100** master module can be used to perform simplified local diagnostics by displaying the slave devices present on the AS-Interface line.

Detailed diagnostics of each of the slave devices is also possible using:

- The **ASITERV2** adjustment terminal
- A Web browser using the Rack Viewer function in the standard Web server on the Modicon X80 I/O platform. For further information, please consult our website [www.schneider-electric.com](http://www.schneider-electric.com).

### References

Description	Usage	Reference	Weight kg/lb
<b>X80 AS-Interface master module</b> supplied with 3-way male SUB-D connector	M4 AS-Interface profile for level V1, V2, and V3 slaves	<a href="#">BMXEIA0100</a>	0.340/ 0.750
<b>Adjustment terminal</b>	For addressing and diagnostics of AS-Interface level V1, V2, and V3 interfaces Powered by LR6 batteries	<a href="#">ASITERV2</a>	1.000/ 2.205



### Presentation

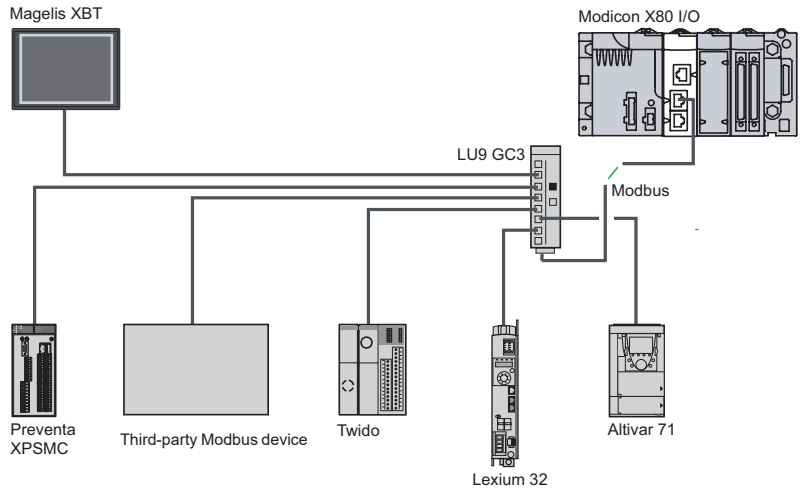

The Modbus serial link is used for master/slave architectures (it is necessary, however, to check that the Modbus services used by the application have been implemented on all relevant devices).

The bus consists of a master station and slave stations. Only the master station can initiate the exchange (direct communication between slave stations is not possible). Two exchange mechanisms are available:

- Question/response, where requests from the master are addressed to a given slave. The master then waits for the response from the slave that has been interrogated.
- Broadcasting, where the master broadcasts a message to all slave stations on the bus. The latter execute the order without transmitting a reply.
- It is necessary to use **BM●CRA31210** modules as drop adapters. On one drop it is possible to plug a maximum of two **BMXNOM0200** modules.

The following services are not available in the slave stations:

- Modbus slave
- Modem services

Although most processors have a serial link that can support modems, the **BMXNOM0200** 2-channel serial link module is particularly recommended for this type of use.

Its performance and numerous parameter-setting options make it ideal for any type of configuration, especially when using radio modems.

### Description

#### BMXNOM0200 serial link module

The front panel of the **BMXNOM0200** serial link module features:

- 1 A screw for locking the module in a slot in the rack
- 2 A display block with 4 LEDs:
  - RUN (green) and ERR (red): Module status
  - For each of the two channels: SER COM (green): Activity on the serial link (lit)/detected fault on a device present on the serial link (flashing)
- 3 Two RJ45 connectors (exclusive use) for connection of channel 0 (with black indicator):
  - 3a A connector for RS 232C connection, marked COM Port 0 RS232
  - 3b A connector for RS 485 connection, marked COM Port 0 RS485
- 4 An RJ45 connector for RS 485 connection of channel 1, marked COM Port 1 RS485, with black indicator

#### To be ordered separately:

RS 485 cordsets (refer to the "Modicon M580 automation platform" catalog available on our website [www.schneider-electric.com](http://www.schneider-electric.com)) or RS 232 cordsets for DCE terminal (see [page 5/27](#)).

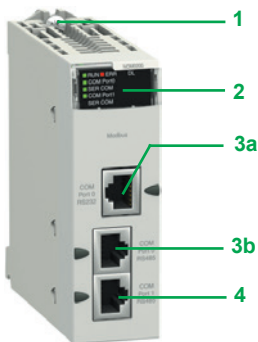

BMXNOM0200

### Complementary characteristics

The following characteristics complement those indicated in the selection guide on [page 5/9](#).

#### BMXNOM0200 module serial links

- Physical interface:
  - RS 232 port 0: RS 232 8-wire, non-isolated
  - RS 485 port 0 and port 1: RS 485 2-wire, isolated
- Frame:
  - Modbus: RTU/ASCII, full duplex in RS 232, half duplex in RS 485
  - Character mode: full duplex in RS 232, half duplex in RS 485
- Data rate:
  - RS 232 port 0: 0.3...115 Kbps (Modbus/Character mode)
  - RS 485 port 0 and port 1: 0.3...57.6 Kbps (Modbus/Character mode)
- Line polarization:
  - Modbus RS 485: automatic
  - RS 485 character mode: configurable with EcoStruxure Control Expert (1) software
- Maximum length of a tap link in RS 485 2-wire:
  - 15 m/49 ft in a non-isolated link
  - 40 m/131 ft in an isolated link
- Expert mode (from version V1.2 of the module and version V5 of Unity Pro (1): used to configure the time out links individually from the application and thus adapt to the specific characteristics of certain modems.

### References (2)

#### X80 Serial link module

Designation	Protocol	Physical layer	Reference	Weight kg/lb
<b>2-channel serial link module (3)</b>	Modbus master/slave RTU/ASCII, Character mode, GSM/GPRS modem	1 non-isolated RS 232 channel (Port 0) 2 isolated RS 485 channels (Port 0 and Port 1)	<b>BMXNOM0200</b>	0.230/ 0.507



BMXNOM0200

#### Cordsets for RS 232 serial link (4)

Designation	Description	Length m/ft	Reference	Weight kg/lb
<b>Cordset for Data Terminal Equipment (DTE)</b> (printer)	Equipped with an RJ45 connector and a 9-way female SUB-D connector	3/ 9.84	<b>TCSMCN3M4F3C2</b>	0.150/ 0.331
<b>Cordset for Data Communication Equipment (DCE)</b> (modem, etc.)	Equipped with an RJ45 connector and a 9-way male SUB-D connector	4-wire (RX, TX, RTS, CTS) 3/ 9.84	<b>TCSMCN3M4M3S2</b>	0.150/ 0.331
	8-wire (excluding RI signal)	3/ 9.84	<b>TCSXCN3M4F3S4</b>	0.165/ 0.364

(1) EcoStruxure Control Expert software continues the Unity Pro range of software and corresponds to versions  $\geq 14$  of Unity Pro.

(2) Requires Unity Pro software  $\geq V1.4$ .

(3) For the ruggedized version, **BMXNOM0200H**, see characteristics on [page 6/9](#).

(4) RS 485 serial link connection (refer to the "Modicon M580 automation platform" catalog available on our website [www.schneider-electric.com](http://www.schneider-electric.com)).

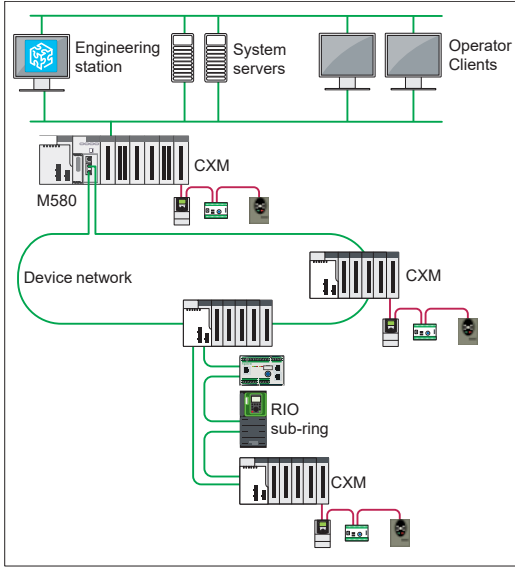

Typical topology to connect CANopen devices to M580/X80 platforms with BMECXM0100

### Presentation

CANopen is an open network supported by more than 600 companies worldwide, and promoted by CAN in Automation (CiA). With the general acceptance of CANopen, Schneider Electric has the accumulated and proven experience of applying CANopen in machine solution platforms.

CANopen helps to ensure reliable and deterministic access to real-time data in field devices. As a consequence, products using CANopen are increasingly used in control system architectures. The **BMECXM0100** CANopen master module provides powerful access to the CANopen slaves from the M580 local rack or a remote X80 drop.

### Advantages

**BMECXM0100** is designed to fulfill customer needs by offering the following advantages:

- Operational intelligence:
  - Complete software integration into Unity with a predefined catalog of preferred devices and numerous automated operations such as device variable creation, IP/DHCP settings, and IO scanner configuration
  - Simple integration of third-party devices
- Maintenance excellence:
  - Robust and well-designed with a long life cycle following X80 standards
  - Built to withstand extreme temperatures (-25 °C to +70 °C/-13 °F to +158 °F), ATEX certified
  - Easy diagnostics by maintenance engineers via a simple Web browser (no need for Unity) and the FDR (Fast Device Replacement) service
- Investment protection: Totally flexible topologies with the possibility of using several **BMECXM0100** modules in a single M580, or in a remote I/O drop closest to the process
- Time-to-market: Simple, compact size, all in one, which reduces installation time
- Enhanced protection and security: Integrated cybersecurity design helps to protect plant operations

### Description

The **BMECXM0100** CANopen X80 master module is standard format (1 slot) and supports one CANopen port (SUB-D9 male connector).

The **BMECXM0100** supports up to 63 slaves with a maximum process image size of 4 Kbytes IN/4 Kbytes OUT.

Standardized baudrates between 20 Kbd and 1 Mbd (20 Kbd, 50 Kbd, 125 Kbd, 250 Kbd, 500 Kbd, 1 Mbd) are supported.

Depending on the performance level required by the process, the **BMECXM0100** module can be scanned by the RIO or the DIO scanner of the M580 CPU. RIO scanning helps to ensure optimum performance, in sync with the PLC task (MAST, FAST or AUX).

Several BMECXM modules can be connected to the same or different I/O scanners in the same M580 PAC.

**BMECXM0100** modules are not compatible with redundant M580 architectures, and cannot be scanned by an Ethernet module including **BMENOC03•1** and **BMXNOC0402**.

Third-party CANopen slaves can only be configured in **BMECXM0100** modules from their EDS description files and via the hardware catalog manager. They cannot be configured from their DTM. Communication between the device and its DTM over Ethernet IO is also not supported.

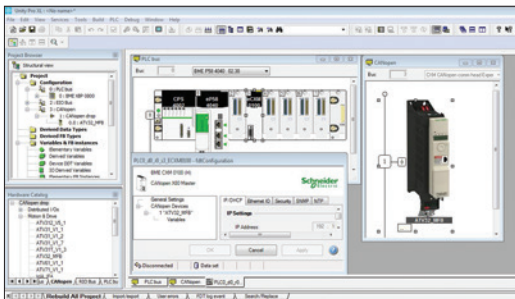

CANopen configuration in Unity Pro with BMECXM0100

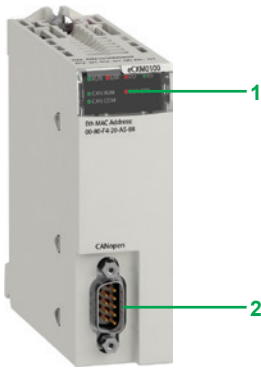

BMECXM0100

### Diagnostics

#### BMECXM0100

The 5 LEDs **1** on the module front panel are used for quick CANopen communication diagnostics:

LED	Color	Description
I/O	Red	Indicates the exchange status with CANopen devices
BS (Bus Status)	Red/Green	Indicates the EtherNet/IP connection status
	Yellow	Firmware upgrade in progress
CAN RUN	Green	Indicates the status of the CANopen fieldbus
CAN ERR	Red	Indicates the status of the CANopen physical layer and indicates detected errors due to missing CAN messages (SYNC, node-guarding, or heartbeat)
CAN COM	Yellow	Dedicated to SDO transmission

### References

Description	Usage	Reference	Weight kg/lb
<b>X80 CANopen master module</b> supplied with male 9-way SUB-D connector <b>2</b>	CANopen communication module used in M580/X80 Ethernet platform	<a href="#">BMECXM0100</a> (1)	–

(1) For the "Conformal coating" version BMECXM0100H, see [page 6/9](#).

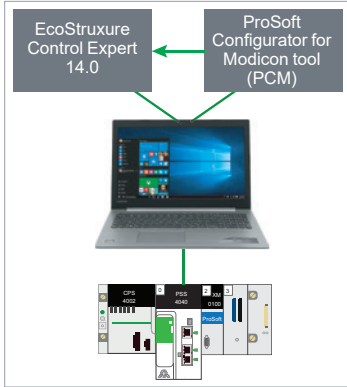

Interaction between EcoStruxure Control Expert, Prosoft Configurator for Modicon (PCM tool), and PMPXM0100 Profibus DP master X80 module

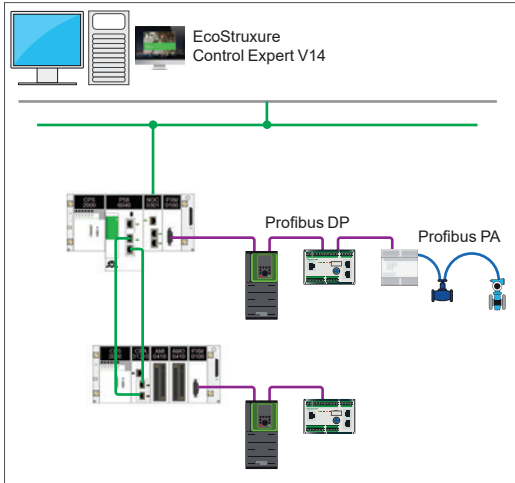

Standalone topology to connect Profibus DP master X80 module to M580/X80 platforms with PMPXM0100

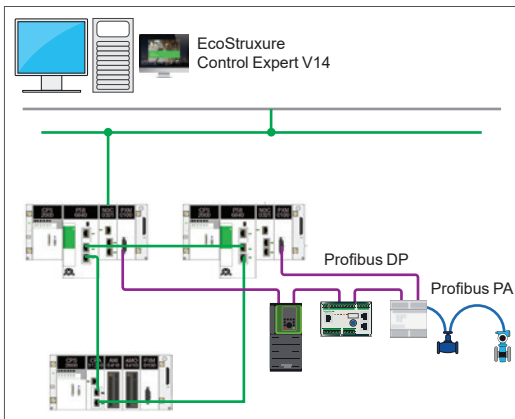

Redundant (HSBY) topology to connect the Profibus DP master X80 module to M580/X80 platforms with PMPXM0100

### Presentation

#### Overview

The X80 Profibus DP master module allows the user to integrate Profibus DP slave devices into Schneider Electric's M580 control system to exchange process, alarming, and diagnostic data with Profibus DP devices as well as to provide configuration and asset management of slave devices using Device Type Managers (DTMs).

This is an advanced in-rack solution for your Profibus system compliant with Hot Standby (HSBY) and Standalone common Safety architectures.

New versions of M580 CPU and BMECRA31210 firmware and software are necessary to operate the module:

- CPU version  $\geq$  V2.80
- BMECRA31210 version  $\geq$  V2.40 if the module is used in a remote drop
- EcoStruxure Control Expert  $\geq$  V14
- ProSoft Configurator for Modicon tool (PCM)

#### Advantages

The X80 Profibus DP master module is designed to fulfill customer needs by offering the following advantages:

- High performance, with up to 125 slave devices behind one module (2 Kb IN/2 Kb OUT), and up to 10 Profibus Masters in one M580 configuration
- Real-time Profibus network analyzer with packet capture tool: accelerates the troubleshooting phase, fine tunes network options, and anticipates any maintenance needs
- Simple and ergonomic ProSoft Configurator for Modicon (PCM) with easy import into EcoStruxure Control Expert to efficiently build the Profibus architecture
- Easy modernization from Quantum PTQ, user-friendly interface
- Achilles Level 2, HTTP, SNMP, Access control & Sys Log

### Description

X80 Profibus DP master module is a Profibus DP V1 master class 2 X80 module that can be plugged in the M580 local rack or in any remote drop supporting the M580 Ethernet backplane depending on the architecture. It has an Autoscan feature to automatically discover and configure all the active slaves connected to the bus.

The PROFIBUS Communication DTM library is provided to enable the module interface by PROFIBUS Asset Management Tools.

"On the fly" operations, such as changing parameters or adding a new device online, are allowed.

The module is refreshed based on the RPI values, asynchronous to the periodic tasks. This refreshment is achieved via the Mast task with limited impact on the task duration, which is proportional to the device number.

The X80 Profibus DP master module can be scanned by the M580 CPU as well as by any Ethernet module (BMENOC●●●●). Nevertheless, the CPU capacity (mainly memory) is designed to be capable of managing all X80 Profibus Master modules installed in the configuration. This simplifies the architecture and the process of modifying slave parameters via the "on the fly" feature, as well as that of adding new devices.

An advanced operating mode provides the option to stop the module while the PLC is in RUN in order to manage any modification without stopping the process.

### Architecture

The PMPXM0100 Profibus DP master X80 module can be integrated into two types of architecture:

- Standalone:
  - Local racks and remote racks
  - Up to 6 modules in one configuration for high-end M580 CPU
  - Common Safety
- Redundant (HSBY):
  - Local rack only
  - Up to 6 modules in each rack for high-end M580 CPU



ProSoft Configurator for Modicon tool (PCM)

### ProSoft Configurator for Modicon tool (PCM)

The following are required to configure the **PMEPXM0100** X80 Profibus DP master module:

- EcoStruxure Control Expert V14
- ControlExpert\_V140\_HF\_PMEPXM0100
- ProSoft Configurator for Modicon tool (PCM)

There is a strong interaction between EcoStruxure Control Expert and the Prosoft Configurator for Modicon (PCM). The ProSoft Configurator for Modicon tool (PCM) also gives the finest level of information and diagnostics on the module, on the bus, and on all the slaves. This tool is available at no additional cost on the Schneider Electric website in the product page section.

The X80 Profibus DP master module is integrated from EcoStruxure Control Expert V14, with high-level services:

- It is included natively in the EcoStruxure Control Expert (1) hardware catalog
- Exhaustive Device DDT for advanced control and diagnostics

Index	Time	Dir	Status	Src	Dest	Function	Details	Src SAP	Dest SAP	PDU	Data
0	0.327093	Rx	Ok	8	1	Response	Data	-	-	00:00:00:00	68:07:07:68:01:0
1	0.331732	Tx	Ok	1	2	Request	SRD - Priority	-	-	02:03	68:05:05:68:02:0
2	0.336113	Rx	Ok	2	1	Response	Data	-	-	03:00:00:00:03	68:05:05:68:02:0
3	0.337257	Tx	Ok	1	1	Taken	-	-	-	-	SC:01:01
4	0.338403	Tx	Ok	1	1	Taken	-	-	-	-	SC:01:01
5	0.339544	Tx	Ok	1	1	Taken	-	-	-	-	SC:01:01
6	0.407684	Tx	Ok	1	1	Taken	-	-	-	-	SC:01:01
7	0.418322	Tx	Ok	1	8	Request	SRD - Priority	-	-	00	68:04:04:68:08:0
8	0.423843	Rx	Ok	8	1	Response	Data	-	-	00:00:00:00	68:07:07:68:01:0
9	0.437481	Tx	Ok	1	2	Request	SRD - Priority	-	-	02:03	68:05:05:68:02:0
10	0.453363	Rx	Ok	2	1	Response	Data	-	-	03:00:00:00:03	68:05:05:68:02:0
11	0.458925	Tx	Ok	1	6	Request	Request FDI Stat.	-	-	-	00:00:01:48:58:98
12	0.519374	Tx	Ok	1	1	Taken	-	-	-	-	SC:01:01
13	0.531013	Tx	Ok	1	8	Request	SRD - Priority	-	-	00	68:04:04:68:08:0
14	0.554553	Rx	Ok	8	1	Response	Data	-	-	00:00:00:00	68:07:07:68:01:0
15	0.558231	Tx	Ok	1	2	Request	SRD - Priority	-	-	02:03	68:05:05:68:02:0
16	0.625613	Rx	Ok	2	1	Response	Data	-	-	03:00:02:02:03	68:05:05:68:02:0
17	0.670258	Tx	Ok	1	1	Taken	-	-	-	-	SC:01:01
18	0.671623	Tx	Ok	1	1	Taken	-	-	-	-	SC:01:01
19	0.623544	Tx	Ok	1	1	Taken	-	-	-	-	SC:01:01
20	0.645184	Tx	Ok	1	1	Taken	-	-	-	-	SC:01:01
21	0.658823	Tx	Ok	1	8	Request	SRD - Priority	-	-	00	68:04:04:68:08:0
22	0.690343	Rx	Ok	8	1	Response	Data	-	-	00:00:00:00	68:07:07:68:01:0
23	0.684895	Tx	Ok	1	2	Request	SRD - Priority	-	-	02:03	68:05:05:68:02:0
24	0.731363	Rx	Ok	2	1	Response	Data	-	-	03:00:02:02:03	68:05:05:68:02:0

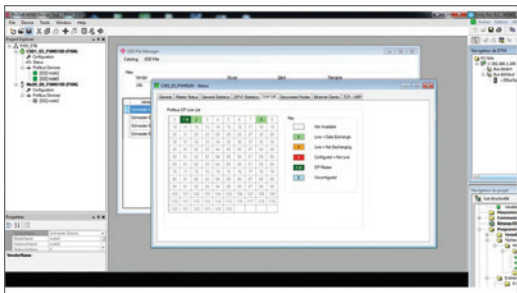

PMEPXM0100 status monitoring - Live List



PMEPXM0100

### Diagnostics and monitoring

#### PMEPXM0100

The 7 LEDs on the module front panel are used for quick Profibus DP fieldbus communication diagnostics.

The X80 Profibus DP master module provides a range of statistics that can assist with module operation, maintenance, and fault finding. The statistics can be accessed by the Prosoft Configurator for Modicon or via the Web server embedded in the module.

### References

Description	Usage	Reference	Weight kg/ lb
<b>X80 Profibus DP Master Module</b>	Profibus master module used for M580 platform fieldbus communication	<a href="#">PMEPXM0100</a>	0.270/ 0.595

(1) EcoStruxure Control Expert software continues the Unity Pro range of software and corresponds to versions ≥ 14 of Unity Pro.

### Presentation

IEC 61850 is the latest worldwide standard for electrical utilities. It covers information modeling, configuration language, and communication networks. Initially developed for communication in substations, implementation of the standard has advanced at a remarkable rate since its introduction, with huge numbers of IEC 61850 devices having been installed. Now considered to be the de facto standard for substation automation, it is encompassing an increasing number of new application areas, such as:

- Wind power (IEC 61400-25)
- Distributed energy resources (IEC 61850-7-420)
- Hydro power (IEC 61850-7-410)

The long-term active participation of Schneider Electric experts in IEC and UCA working groups has resulted in a state-of-the-art Schneider Electric IEC 61850 offer with full IEC 61850-8-1 functionality.

IEC 61850 with M580 helps reduce customer investment and operational costs by easily connecting their power device to the process systems.

M580 IEC 61850 helps to improve system reliability and security by:

- Getting the right data at the right time to be able to act proactively, thus increasing the reliability and availability of both the process and the power system
- Implementing robust M580 cybersecurity features to help ensure secure communication

### Functionality

IEC 61850 MMS server, client, and GOOSE services can work in either Ed. 2.0 or Ed. 1.0 mode. M580 controllers support IEC 61850 standard engineering process and data objects. They also support the following data models:

- Substation automation systems (IEC 61850-7-4)
- Hydroelectric power plants (IEC 61850-7-410)
- Distributed energy resources (IEC 61850-7-420)

The **BMENOP0300** module from the Schneider Electric EcoStruxure platform is used to implement an engineering approach by enabling IEC 61850 compliant data exchange across industrial, energy, and power system applications. This offer helps our existing PLC customers from both process and energy applications to modernize smoothly and sustainably to the new IEC 61850 standard.

### Application cases

The **BMENOP0300** module can provide different services under different roles, primarily in the following three areas:

- 1 Electrical device integration
  - IEC 61850 Client is used to communication with IEDs.
  - GOOSE is also possible.
- 2 IEC 61850 based process control
  - Process control objects are modeled with IEC 61850 (hydro, DERs, etc.).
  - Server to SCADA and Client to IEDs is possible when needed.
- 3 M580 provides information to other systems.
  - IEC 61850 Server is used.

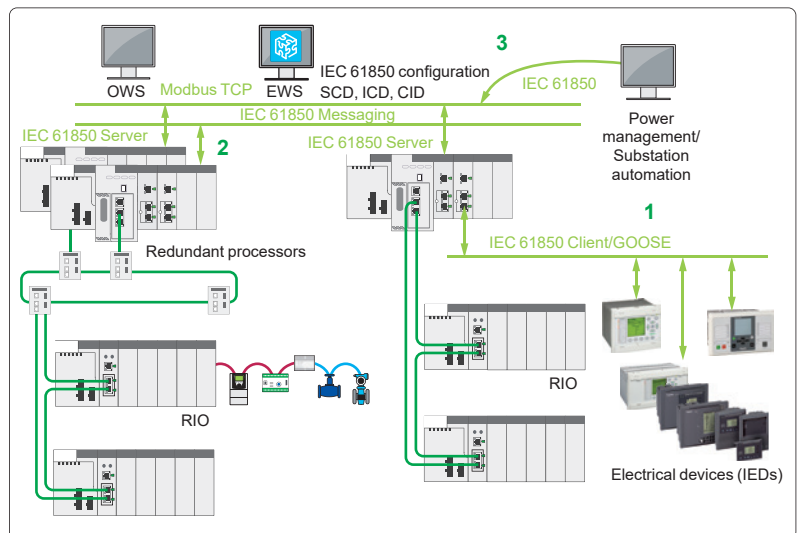

Different services that **BMENOP0300** can provide

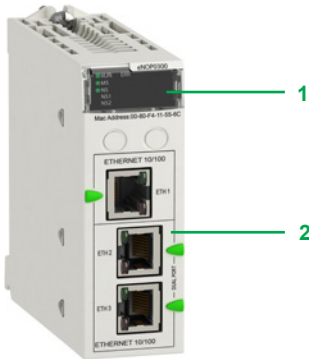

BMENOP0300

### Description

The **BMENOP0300** IEC 61850 module is installed on the local Ethernet backplane of an M580 system.

The 6 LEDs on the front panel **1** are used to diagnose operating conditions:

- RUN LED (green): Operating status
- ERR LED (red): Error detected
- MS LED (green/red): Module status
- NS LED (green/red): Network connection status
- NS1 LED (green/red): Ethernet network status
- NS2 LED (green/red): Ethernet network status

With three Ethernet ports **2** to link external intelligent electrical devices (IEDs), the module provides interfaces for IEC 61850 communication as well as device management software that utilizes the IEC 61850 standard (1).

The maximum number of **BMENOP0300** modules that can be mounted on a local rack is determined by the M580 processor model:

Standalone processor model	<b>BMEP581020</b>	<b>BMEP583020</b>	<b>BMEP584020</b>
	<b>BMEP582020</b>	<b>BMEP583040</b>	<b>BMEP584040</b>
	<b>BMEP582040</b>		<b>BMEP585040</b> <b>BMEP586040</b>
High-availability processor model	<b>BMEH582040</b>		<b>BMEH584040</b> <b>BMEH586040</b>
Maximum number	<b>2</b>	<b>3</b>	<b>4</b>

### Main features

The main features of the **BMENOP0300** module are as follows:

- Compatible with the entire range of M580 CPUs, in both standalone and redundant configuration:
  - Ring topologies on 2 Ethernet ports using RSTP (Rapid Spanning Tree Protocol)
- Cybersecurity features:
  - IEC 62443/ISA99 Achilles Level 2 certification
  - IPSec for IP-based communication
- IEC 61850 services:
  - MMS messaging server and client
  - GOOSE publisher and subscriber
- Network management using SNMP (Simple Network Management Protocol)
- Time synchronization: to be able to synchronize with external time servers and update the internal clock
- Modbus TCP support (limited, no I/O scanning)

### Capabilities

The capabilities per module are:

- 16 logical devices
- MMS server: 16 concurrent connections, 64 report control blocks instances, 8 instances for one report control block, 68 data sets, 256 data attributes/data set, URCB and BRCB reports
- Control model: DOes, SBOes, DOns, SBOs
- MMS client: 32 concurrent connections
- GOOSE: 4 control blocks for GOOSE publish and 32 control blocks for GOOSE subscribe, up to 256 inputs/data set

### References

Description	Usage	Reference	Weight kg/lb
<b>X80 IEC 61850 communication module</b>	IEC 61850 communication module used in M580 local rack Ethernet backplanes	<b>BMENOP0300</b> (2)	0.345/ 0.761

(1) Requires Unity Pro software V12.0 or later; see our website [www.schneider-electric.com](http://www.schneider-electric.com).

(2) For the "Conformal coating" version BMENOP0300C, see [page 6/10](#).





PMXNOW0300 Wi-Fi access point

### Presentation

The **PMXNOW0300** Acksys partner Wi-Fi access point module consists of a WLAN wireless connection combined with a 3-port 10/100 Ethernet switch. This module is designed to be integrated in the Modicon X80 I/O platform Modicon processor (1). It retrieves the 24 V voltage from the backplane rack and occupies one slot in it. An Ethernet cable, supplied with the module, must be used to connect the Wi-Fi module to the processor or the communication module (BMXNO●●●●●). This module offers the following functions:

- Access point
- Ethernet bridge
- Wi-Fi repeater

The PMXNOW0300 is compatible with the majority of Ethernet-based protocols, including Modbus TCP, EtherNet/IP, etc. It also allows Wi-Fi access to the associated Modicon processor from Vijeo Citect and EcoStruxure Control Expert software as well as data exchanges between automation platforms.

The PMXNOW0300 module can be removed and replaced while the rack is powered up. It is compatible with Vijeo Design' Air and Vijeo Design' Air Plus, allowing the HMI to be remotely located on a tablet or smartphone (2).

### Main characteristics

#### Type of device

Wi-Fi access point, client and repeater

#### Wi-Fi standards

IEEE 802.11 a/b/g/h

#### Operating frequencies

2.4 GHz and 5 GHz

#### IP rating

IP30

#### Mounting

On the rack

#### Number of radios

1

#### Nominal data rate

≤108 Mbps (Super AG mode, 54 Mbps in standard mode)

#### Antenna connections

1 x RP-SMA

#### Ethernet connections

3 x 10/100 BASE TX, MDI-MDIX

#### Wi-Fi connections

1 x WLAN interface

#### Range

Up to 300 m/984 ft in free field with the antenna supplied as standard and up to 5 km/3 mi with external antenna (frequency range and data rate dependent on antenna type)

#### Dimensions

97 x 32 x 104 mm/3.82 x 1.26 x 4.09 in.

#### Storage temperature

- 40 °C to + 80 °C/- 40 °F to + 176 °F

#### Humidity

Max. 95% (non-condensing)

#### Supply voltage

+ 24 V  $\pm$  from the Modicon X80 I/O platform rack

#### Consumption

3.5 W typical

(1) Only for processors compatible with the Modicon X80 I/O platform (see page 1/8).  
 (2) For more information, please consult our website [www.schneider-electric.com](http://www.schneider-electric.com).

### References

#### X80 Wi-Fi access point module

Description	Number of radios	Data rate	IP rating	Reference	Weight
		Mbps			
<b>Wi-Fi 802.11a/b/g/h access point (1)</b> with antenna and 50 cm/19.69 in. Ethernet cable equipped with two RJ45 connectors, plus CD-ROM	1	≤108 (Super AG mode, 54 Mbps in standard mode)	IP30	<b>PMXNOW0300</b> (2)	0.205/ 0.452

#### Technology

Partner

**Schneider**  
Electric

(1) Partner Product, sold by SE and Acksys. Supported by Acksys, see our website [www.schneider-electric.com/en/partners/technology-partners/](http://www.schneider-electric.com/en/partners/technology-partners/)

(2) To order this product, please contact our Customer Care Center.

**Technology**

Partner



PMEGPS0100 module

**Presentation**

The **PMEGPS0100** Monaghan partner GPS time server module **1** is a precision network server and serial time server with a GPS interface **2**. It provides time for network connected devices using Precision Time Protocol (PTP) and Network Time Protocol (NTP) and for direct connected devices using IRIG-B and DFC-77 time protocols.

The **PMEGPS0100** module is specifically designed to operate with the BMXERT1604 time-stamping module **3** (see pages 3/32 to pages 3/33) and supplies the required 5 VDC IRIG-B or 24 VDC DCF-77 time code signals.

The **PMEGPS0100** module is installed on the Ethernet backplane:

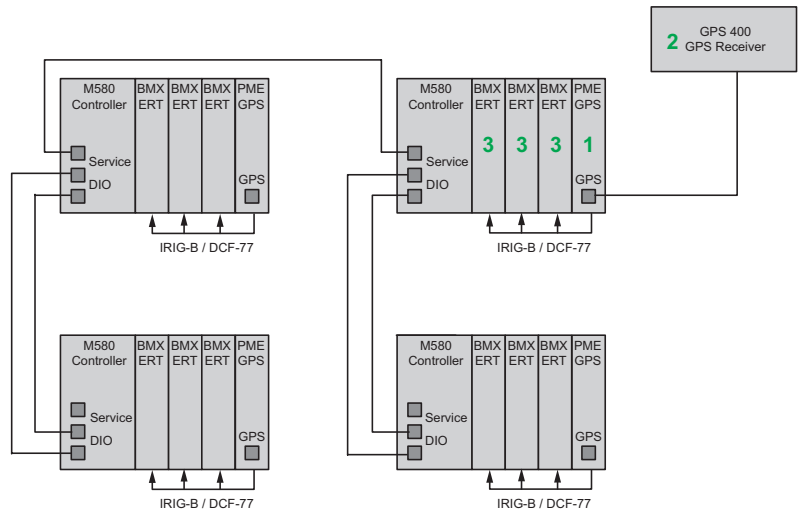

**Operating modes**

Three operating modes are available:

- PTP Grand Master clock mode: The **PMEGPS0100** module is connected to a GPS receiver and its internal clock synchronizes with the GPS satellite.
- PTP Slave clock mode: The **PMEGPS0100** module is not connected to a GPS receiver and searches on the network for a PTP master clock to synchronize with.
- Master clock mode: The **PMEGPS0100** module's internal crystal oscillator is used as the time base for synchronizing.

**Advantages**

- Device DDT with enhanced diagnostics to be used in the customer application
- Web-based diagnostics
- Simple, compact size, all in one, which reduces installation time
- Supports hot-swap operation
- Compliant with Modicon M580 architectures, including redundant architectures
- Simplex operation is supported in both local and remote Ethernet X80 racks
- Embedded Web server for data access and configuration
- NTP time server for M580 CPU
- Automatically switches between GPS and network time synchronization
- Network time synchronization supports multiple master clocks with automatic failover

### Diagnostics and wiring

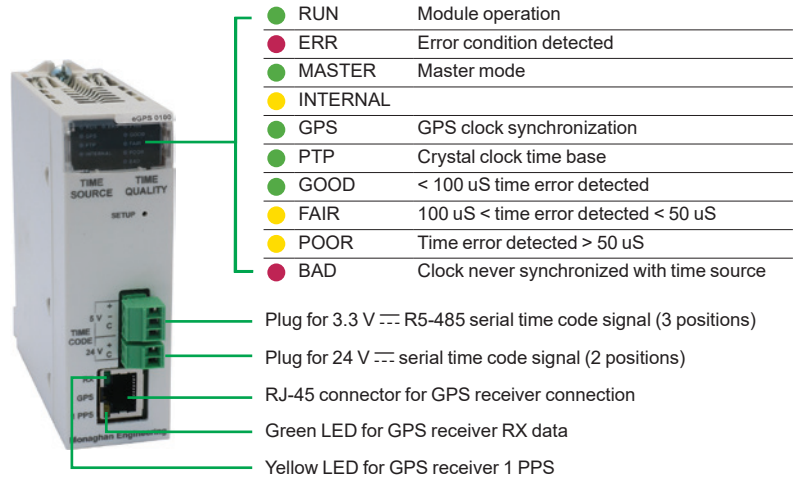

### Characteristics

#### Time and GPS position data

Available to the M580 CPU

#### Product compatibility

- Processor: BMEP58●●●
- Drop adapter: BMECRA31210
- Backplane: BMEXBP●●●

#### Power consumption in W

170 mA @ 3.3 V  $\approx$  0.561 W  
100 mA @ 24 V  $\approx$  2.4 W

#### Consumption on the Ethernet backplane bus

1.4 W

#### Time code protocols

- Serial:
  - IRIG-B Time Code Generator
  - DCF-77 Time Code Generator
- Network:
  - IEEE-1588 Precision Time Protocol (PTP)
  - Network Time Protocol (NTP)

#### Serial time code outputs

3.3 V  $\approx$  RS-485 differential 32 loads maximum  
24 V  $\approx$  unipolar @ 100 mA maximum sink or source

#### Accuracy

+/- 1  $\mu$ S 95%

#### Wiring connectors

3-position plug for 3.3 V  $\approx$  RS-485 serial time code signal  
2-position plug for 24 V  $\approx$  serial time code signal  
RJ-45 connector for GPS receiver connection

### References

Description	References	Weight kg/lb
X80 GPS synchronized time server (1)	<a href="#">PMEGPS0100</a>	0.180/ 0.396



(1) Partner Product, sold and supported by Monaghan Engineering partner, see our website [www.schneider-electric.com/en/partners/technology-partners/](http://www.schneider-electric.com/en/partners/technology-partners/)

Technology  
Partner

Schneider  
Electric

PMESWT0100 Scaime partner  
weighing module

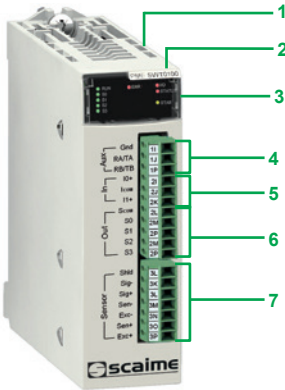

PMESWT0100

### Presentation

The **PMESWT0100** Scaime partner weighing module is integrated in a Modicon X80 I/O platform with an Ethernet + X-bus **BMEXBP●●00(H)** rack and a Modicon M580 **BMEP58●0●0** PLC or in a Modicon X80 RIO drop with an Ethernet + X-bus **BMEXBP●●00(H)** rack and a **BMECRA31210** adapter.

With this module it is possible to go beyond the scope of a simple weighing application.

It is suitable for static weighing applications such as silo level measurement and scale weighing and it is also well suited to low-speed dynamic weighing applications such as filling, dosing, and material transfer.

The Modicon X80 I/O platform can manage the whole weighing environment as well as the whole machine or industrial process associated with the weighing system. Indeed, weighing data is accessible by the PLC via implicit exchanges or explicit commands. Once the weighing signal is received, it is processed and transferred by the weighing module to the Modicon M580 PLC via the Ethernet backbone. This Ethernet weighing transmitter offline configuration, online calibration, monitoring, and weighing diagnostics are achieved using EcoStruxure Control Expert (1) software via FDT/DTM.

The Scaime partner weighing module has been developed to comply with the general standards and certifications of the Modicon X80 I/O platform. For more information, see [page 8/2](#) or consult our website [www.schneider-electric.com](http://www.schneider-electric.com).

### Description

The **PMESWT0100** weighing module features the following:

- 1 A rigid body providing support and protection for the electronic card
- 2 A module reference marking (a label is also visible on the right-hand side of the module)
- 3 A module and channel status display block
- 4 Screw terminals for connecting an external HMI output
- 5 Screw terminals for connecting discrete reflex inputs
- 6 Screw terminals for connecting discrete reflex outputs
- 7 Screw terminals for connecting input load cells

### Main characteristics

#### Measurement input

1 weighing channel per module, comprising up to 8 load cells connected via junction box

#### Input load cell supply voltage

5 V  $\overline{\text{---}}$

#### Internal resolution

24-bit converter

#### User resolution

Up to 1,000,000, factory-calibrated 500,000 at 2 mV/V

#### Internal measurement rate

6 to 400 measurements per second

#### External measurement rate

100 measurements per second

#### Discrete reflex outputs

#### Number of applications

4 positive logic outputs, 2 for dosing and 2 for threshold monitoring

#### Maximum voltage

55 V  $\overline{\text{---}}$

#### Nominal current

400 mA

#### Response time

2 ms discrimination

#### Discrete inputs

#### Number of applications

2 positive logic inputs, weighing functions

#### Low voltage range

0...3 V  $\overline{\text{---}}$

#### High voltage range

9...28 V  $\overline{\text{---}}$

#### High current

20 mA at 24 V  $\overline{\text{---}}$

(1) EcoStruxure Control Expert software continues the Unity Pro range of software and corresponds to versions  $\geq 14$  of Unity Pro.



PMESWT0100

### References

#### Weighing module

Description	Composition	Reference	Weight kg/lb
<b>Scaime partner weighing module (1)</b> (1 weighing channel per module)	<ul style="list-style-type: none"> <li>- Load cell input 100 measurements/s (for 1 to 8 load cells)</li> <li>- 4 discrete reflex outputs (for threshold monitoring and dosing)</li> <li>- 2 discrete inputs (for weighing functions)</li> <li>- 1 output for an external HMI</li> </ul>	<b>PMESWT0100 (2)</b>	0.233/ 0.514

Technology  
Partner



(1) Partner Product, sold by SE and Scaime. Supported by Scaime, see our website [www.schneider-electric.com/en/partners/technology-partners/](http://www.schneider-electric.com/en/partners/technology-partners/)

(2) To order this product, please contact our Customer Care Center.

Technology  
Partner

Schneider  
Electric

### Presentation

The **PMXCDA0400** Prosyst partner diagnostic module is a powerful solution designed to improve M340 and M580 PLC system behavior as far as debugging, setting, diagnostics, predictive maintenance, safety, process traceability, control and optimization, etc., are concerned. It is installed on the X-bus where it detects and time-stamps all I/O evolutions, at the same pace as they are refreshed by the PLC tasks (Mast or Fast), and with full transparency.

Target segments include:

- Manufacturing
- Modular and complex machines
- Infrastructure and applications with strict functional safety restrictions

The main features of the **PMXCDA0400** module are as follows:

- Single slot module for M340 and M580 PLCs
- Local storage capacity for the "Black Box" function
- Ethernet and USB ports (Host and Device) on the front of the module
- Consumption on the X-bus: 1.1 A

The **PMXCDA0400** module is to be used with the AIDMAPII V2.6 software (PLX ADGxxx).

### Description

#### Technical features

- Single slot module, to be installed on the X-bus
- Power consumption: 1.1 A on the 3.3 V bus supply (peak 1.7 A)
- On the front of the module:
  - 1 A mini-USB port (USB "device") for changing the IP address
  - 2 An RJ45 CANopen port for direct connection on the CAN bus (CANopen I/O monitoring not available for the V1.0 version of **PMXCDA0400**)
  - 3 A USB port (USB "host") to back up the **PMXCDA0400** mass memory
  - 4 An RJ45 connector for Ethernet TCP/IP communication
- Flash disk memory available for local data storage
- Powerful dual-core processor (allowing the development of customized solutions to meet specific customer needs)
- Main **PMXCDA0400** function: detection of any I/O changes on the X-bus, when the I/O are refreshed by the PLC CPU. **PMXCDA0400** can also monitor internal PLC variables if needed.
  - I/O systems and PLC variables monitoring for:
    - Any type of I/O refreshed on the X-bus segment (in-rack, IO Scanning, AS-Interface)
    - Application's internal variables and "system" variables

#### PMXCDA0400 module features

- Compatible with all types of M340 and M580 CPU, as well as all UNITY Pro/ EcoStruxure Control Expert applications
- No declaration required during PLC configuration
- Can be installed in any slot on the main rack or any extension rack of the M340 or M580 PLC
- Module insertion is possible when the PLC is running
- Automatically downloads the PLC configuration (via the X-bus), analyzes it, and starts to record all of the I/O evolutions ("plug and play") - the **PMXCDA0400** module is ready in parallel to provide OPC client connected applications
- A software configuration tool allows the user to specify the I/O list to monitor, and to declare the internal PLC variables that they wish to log (%M, %MW, %MD, %MF, %S, %SW).

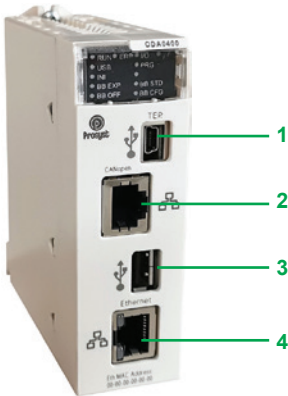

PMXCDA0400 module

### Operating modes

Two main operating modes are available for the **PMXCDA0400** module:

#### Continuous data acquisition mode

One or several applications are connected to the **PMXCDA0400** networked module(s), in order to acquire, diffuse, and store the I/O evolutions time-stamped by the **PMXCDA0400** module.

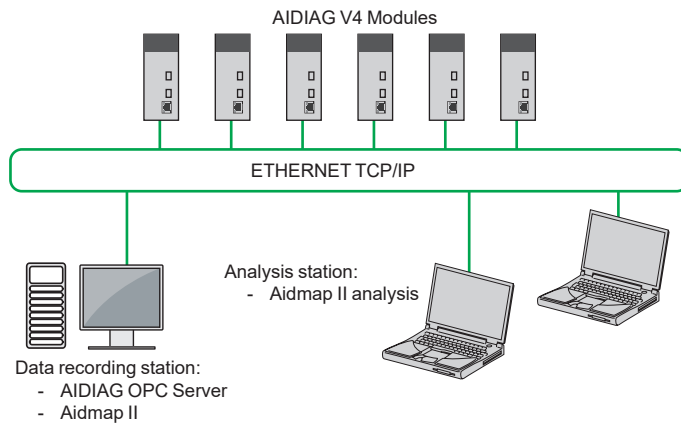

- Communication between the **PMXCDA0400** module(s) and the client applications may use Ethernet TCP/IP (RJ45 port on the front of the module: 100 MB).
- These client applications may be:
  - The OPC server, for providing OPC client applications with **PMXCDA0400** data (AIDMAPII software PLXADGxxx), or any other OPC client (SCADA application...)
  - The "Black Box" management software, provided with the **PMXCDA0400** module, to periodically back up the **PMXCDA0400** mass memory (no continuous flow of data on the network)

#### "Standalone" mode

This mode is used to download all or part of the mass memory "on demand":

- The embedded storage of the process data evolutions is a large "rotating buffer" with a huge storage capacity, depending on the type and number of variables monitored by the **PMXCDA0400** module, and depending on the process dynamics (can store months of process history).
- The archives obtained by emptying the mass memory are used to generate AIDMAPII files, with the option to automatically import a predefined AIDMAPII configuration, in order to provide instant analysis or statistics for the corresponding period of time.

This mode is also used for periodic local connection of a data logger (PC station with the AIDMAPII software PLXADGxxx).

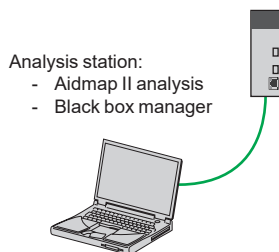

### References

Description	Reference	Weight kg/lb
<b>X80 diagnostic module (1)</b>	<b>PMXCDA0400</b>	—
AIDMAPII V2.6 software (PLXADGxxx)		



(1) Partner Product, sold and supported by our Prosysy Partner. See our website [www.schneider-electric.com/en/partners/technology-partners/](http://www.schneider-electric.com/en/partners/technology-partners/)



Technology

Partner

Schneider  
Electric

5

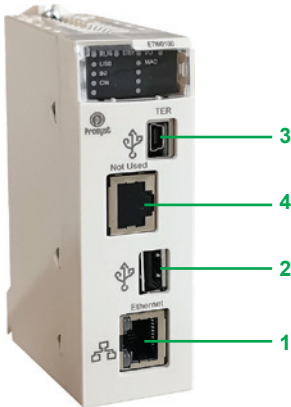

PMXETW0100 Ethway module

### Presentation

The **PMXETW0100** Prosyst partner Ethway module helps to ensure connectivity between M580 and Telemecanique legacy ranges (Premium & TSX Series 7) through the X-Way communication protocol Ethway. It also helps to ensure connectivity between M580 and the APRIL legacy range.

**PMXETW0100** provides three main services:

- UNITE server
- UNITE client
- Common words

### Advantages

The **PMXETW0100** module provides a simple and consistent solution to interconnect M580 to the Telemecanique and APRIL legacy ranges using the Ethway protocol (Premium, TSX Series 7), even though the M580 does not support X-Way protocols. This offers users the option to connect an M580 CPU in an Ethway network during the migration phase.

Target segments:

- Manufacturing industry (automotive, etc.)
- Steel, metal
- Energy (off-shore, hydroelectric, etc.)
- Infrastructure (airports, etc.)
- Consumer Packaged Goods

### Description

#### Technical overview

- **PMXETW0100** is a single slot module, to be installed on the X-bus.
- Valid for M580 PLC only.
- Power consumption is 1.1 A on the 3.3 V bus supply (peak 1.7 A).
- A maximum of 2 modules is allowed in an M580 configuration (local rack). They cannot be mounted on extended eRIO racks.
- **PMXETW0100** does not provide an X-Way router function between 2 Ethway modules.
- The module is configured via the web page.
- Support three types of function exclusively: UNITE Server, UNITE Client, and Common Words
- The module implements requests from version 1 and 2 of the UNITE protocol.

#### Hardware overview

The **PMXETW0100** module includes:

- 1 Only one Ethernet port to connect the system to the inter-controller network
- 2 One USB port (USB "host") to allow installation and update of the module firmware
- 3 A mini-USB to access the web page
- 4 A second RJ45 port, not used for this module, equipped with a protective plug

The **PMXETW0100** module shares its data with the M580 PLC under an X-bus service.

### Use cases

#### Use case 1: Communication through a common network

In this use case, the **PMXETW0100** module is used to enable the M580 PLC to integrate an Ethway network by providing the functional level as close as possible to a real Ethway module of a TSX7 or APRIL PLC.

It allows users to interconnect the M580 to a Telemecanique or APRIL legacy range throughout the migration phase.

The M580 is capable of communicating directly through Ethway with the devices sharing its network. Each M580 controller integrated in the Ethway network is equipped with an Ethway module.

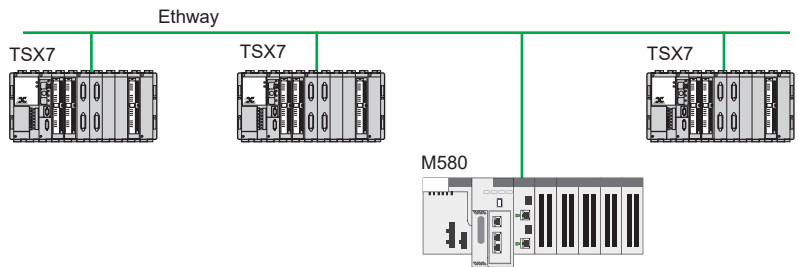

#### Use case 2: Communication through a subnetwork

In this use case, the M580 can access a subnetwork using a station from its network as a bridge. This allows the M580 to communicate via another X-way network (FipWay, MapWay). However, the M580 cannot access stations communicating through a fieldbus (UniTelWay, FIPIO).

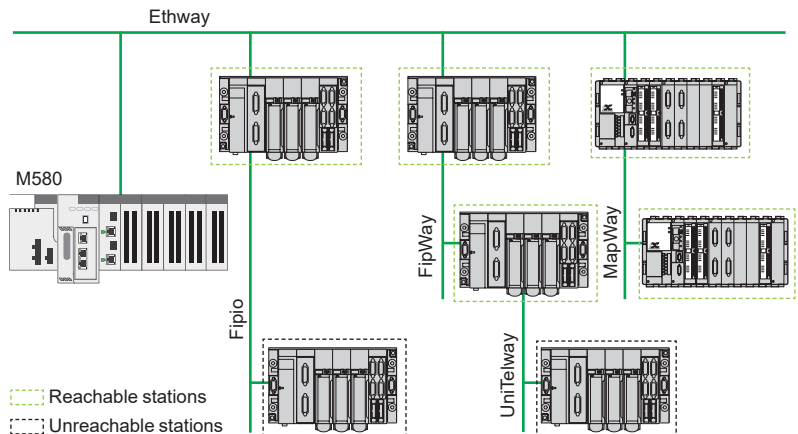

5

### References

Description	References	Weight kg/lb
X80 Ethway module (1)	<b>PMXETW0100</b>	–

Technology  
Partner

(1) Partner Product, sold and supported by our Prosysy Partner. See our website [www.schneider-electric.com/en/partners/technology-partners/](http://www.schneider-electric.com/en/partners/technology-partners/)



---

## Treatment for severe environments

- Presentation..... [page 6/2](#)
- Harsh chemical environments..... [page 6/2](#)
- Extreme climate environments..... [page 6/2](#)

## X80 ruggedized power supply modules

- References ..... [page 6/3](#)

## X80 ruggedized racks and rack expansion module

- References ..... [page 6/4](#)

## X80 ruggedized discrete I/O modules

- References ..... [page 6/6](#)

## X80 ruggedized analog I/O modules

- References ..... [page 6/7](#)

## X80 ruggedized communication modules and network gateway

- References ..... [page 6/9](#)

## X80 ruggedized application-specific modules

- References ..... [page 6/11](#)

### Presentation

#### Protective treatment of Modicon X80 I/O platform

The Modicon X80 I/O platform complies with "TC" treatment requirements (treatment for all climates). It is designed as standard to operate in temperatures ranging from 0 to +60 °C/32 to 140 °F. For installations in industrial environments corresponding to "TH" (treatment for hot and humid environments), devices must be housed in enclosures providing at least IP54 protection as specified by standard IEC/EN 60529, or an equivalent level of protection according to NEMA 250.

The Modicon X80 I/O platform offers **IP20 protection** (1). It can therefore be installed without an enclosure in reserved access areas that do not exceed **pollution level 2** (control room with no conductive dust). **Pollution level 2** does not take account of harsher environments, such as those where the air is polluted with conductive dust, fumes, corrosive or radioactive particles, vapors or salts, molds, insects, etc. All the safety hardware in-rack modules colored red (processor, coprocessor, X80 I/O) are conformal coated for use in severe environments.

#### Treatment for severe environments

If the Modicon X80 I/O platform has to be used in more severe environments or is required to start and operate in an extended temperature range, from **-25 °C to +70 °C/-13 °F to 158 °F** (only H or T version), the "ruggedized" offer features industrially hardened processor and power supply modules, X-bus and Ethernet I/O modules and racks that have a protective coating on their circuit boards.

**Note:** Capable of starting within an extended temperature range (from -25 °C to +70 °C/-13 °F to 158 °F, a single-rack configuration is also able to operate at extremely low temperatures (as low as -40 °C/-40 °F) if placed in an appropriate enclosure. Please contact our Customer Care Center.

The coated/harsh offer provides the Safety CPU/coprocessor and Safety I/O modules with "AVR 80" coating on their electronic cards. This treatment increases the isolation capability of the circuit boards and their resistance to:

- Condensation
- Dusty atmospheres (conducting foreign particles)
- Chemical corrosion, in particular during use in sulfurous atmospheres (oil refinery, purification plant, etc.) or atmospheres containing halogens (chlorine, etc.) or chemical vapors

This protection, combined with appropriate installation and maintenance, enables Modicon X80 I/O products to be used in the following environments:

#### ■ Harsh chemical environments (products with suffix 'H' and 'C'):

The use of contact grease protection on connectors, removal blocks is mandatory to meet these requirements. The lubricant protection seals electrical contacts from oxygen, moisture, aggressive gasses, and other hostile elements.

- **IEC/EN 60721-3-3 class 3C4:**
  - 7 days; 25 °C/77 °F relative humidity 75%
  - Concentrations (ppb): H<sub>2</sub>S: 9,900/SO<sub>2</sub>: 4,800/Cl<sub>2</sub>: 200
- **ISA S71.04 classes G1 to Gx:**
  - 14 days; 25 °C/77 °F relative humidity 75%
  - Concentrations (ppb): H<sub>2</sub>S: 60/SO<sub>2</sub>: 350/Cl<sub>2</sub>: 1,450/NO<sub>2</sub>: 12
- **IEC/EN 60068-2-52 salt mist, Kb test severity level 2:**
  - 3 x 24-hour cycles
  - 5% NaCl
  - 40 °C/104 °F relative humidity 93%
- **Extreme climate environments (products with suffix 'H' and 'T'):**
  - Temperatures ranging from -25 to +70 °C/-13 to 158 °F
  - Relative humidity levels up to 93% from -25 °C/-13 °F to +60 °C/140 °F
  - Formation of ice
  - Altitudes from 0 to 5,000 m/0 to 16,404 ft

**Note:** Some products with the suffix 'C' also operate in an extended temperature range (from -25 °C to +60 °C/-13 °F to 140 °F). Please contact our Customer Care Center.

#### Specific characteristics for Safety modules

All the Safety modules are coated and only exist with this surface treatment. There is no T, C, or H extension in the product references. Safety modules are compatible with:

- a temperature range from -25...+60 °C/-13...140 °F
- corrosive environments using common H components

**A protective gel is needed to cover all electrical connections on X80 products used in corrosive environments.**

This gel comes in a 25 g tube and can be ordered separately under the reference **BMXGEL0025**.

(1) Each slot in a **BM•XBP•••00** rack is equipped as standard with a protective cover that should only be removed when inserting a module. If any covers are subsequently misplaced, replacements can be ordered under reference **BMXXEM010** (sold in lots of 5).

F19\_ACC\_CPMF517008



BMXGEL0025



BMXCPS3020H



BMXCPS3500H



BMXCPS4002H



BMXCPS4022H



BMXCPS3522H

## Composition

### References and characteristics

To order ruggedized modules and racks, see the reference from below to [page 6/11](#) (the references of the ruggedized products available include the suffix "H" and the conformal coated products available include the suffix "C"). The standard separate parts (cordsets, cables, sub-bases, etc.) that are compatible with the ruggedized modules offer are listed in the reference pages (see from below to [page 6/11](#)).

The majority of operating and electrical characteristics of ruggedized modules are identical to those of their equivalent standard versions. However, some characteristics are subject to either derating or limitation. Please consult our website [www.schneider-electric.com](http://www.schneider-electric.com).

## Ruggedized power supply modules

Each **BM●XBP●●00H** rack must be equipped with a power supply module. **BMEXBP●●02H** must be equipped with 1 or 2 redundant power supply modules. These modules are inserted in the leftmost power supply slots of each rack (marked CPS).

The available power values given below in **bold italic** correspond to operation at  $-25\text{ }^{\circ}\text{C}/-13\text{ }^{\circ}\text{F}$  and  $+70\text{ }^{\circ}\text{C}/+158\text{ }^{\circ}\text{F}$  (see temperature derating curves on our website [www.schneider-electric.com](http://www.schneider-electric.com)).

The power required to supply each rack depends on the type and number of modules installed in the rack. It is therefore necessary to draw up a power consumption table for each rack in order to determine which is the most appropriate **BMXCPS●●●●H** power supply module for your requirements (consult our website [www.schneider-electric.com](http://www.schneider-electric.com)).

### Power supply modules (1)

Line supply	Available power (2)			Reference	Weight kg/lb
	3.3 V $\overline{\text{---}}$ (3)	24 V $\overline{\text{---}}$ rack (3)	24 V $\overline{\text{---}}$ sensors (4)		
24...48 V $\overline{\text{---}}$ isolated	15 W	32 W	–	<b>BMXCPS3020H</b>	0.340/ 0.750
	<b>11.3 W</b>	<b>23.4 W</b>			
100...240 V $\sim$	15 W	31.2 W	21.6 W	<b>BMXCPS3500H</b>	0.360/ 0.794
	<b>11.3 W</b>	<b>23.4 W</b>	<b>16.2 W</b>		
	18 W	40 W	–	<b>BMXCPS4002H</b>	0.360/ 0.794
	<b>18 W</b>	<b>40 W</b>	<b>40 W</b>		
24...48 V $\overline{\text{---}}$	18 W	40 W	–	<b>BMXCPS4022H</b>	0.810/ 1.786
	<b>18 W</b>	<b>40 W</b>	<b>40 W</b>		
125 V $\overline{\text{---}}$	18 W	40 W	–	<b>BMXCPS3522H</b>	0.610/ 1.345
	<b>18 W</b>	<b>40 W</b>	<b>40 W</b>		

### Standard separate part

Description	Type	Composition	Reference	Weight kg/lb
Set of 2 removable connectors	Spring-type	One 5-way terminal block and one 2-way terminal block	<b>BMXXTSCPS20</b>	0.015/ 0.033

### Standard replacement part

Description	Type	Composition	Reference	Weight kg/lb
Set of 2 removable connectors	Caged	One 5-way terminal block and one 2-way terminal block	<b>BMXXTSCPS10</b>	0.020/ 0.044

(1) Includes a set of 2 removable caged connectors **BMXXTSCPS10**.

(2) The total power consumed on each voltage (3.3 V  $\overline{\text{---}}$  and 24 V  $\overline{\text{---}}$ ) must not exceed the total power of the module. See the power consumption table on our website [www.schneider-electric.com](http://www.schneider-electric.com).

(3) 3.3 V  $\overline{\text{---}}$  and 24 V  $\overline{\text{---}}$  rack voltages for powering Modicon M340 and M580 PLC modules.

(4) 24 V  $\overline{\text{---}}$  sensor voltage for powering the input sensors (voltage available via the 2-way removable connector on the front panel).

# Modicon X80 modules platform

## Dedicated parts for severe environments

### Ruggedized racks and rack expansion module

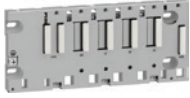

BMXXBP0400H

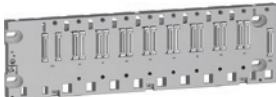

BMEXBP0800H



BMXXBE1000H



BMXXSP000 + BMXXSP300

Ruggedized racks					
Description	Type of module to be inserted	No. of slots (1)	Power consumption (2)	Reference	Weight kg/lb
<b>Ruggedized X-bus racks</b>	BMXCPS power supply, BMXP34 or BMEP58 processor, BMEH58 processor, I/O modules, and application-specific (counter and communication) modules	4	1 W	<a href="#">BMXXBP0400H</a>	0.630/ 1.389
		6	1.5 W	<a href="#">BMXXBP0600H</a>	0.790/ 1.742
		8	2 W	<a href="#">BMXXBP0800H</a>	0.950/ 2.094
		12	0.74 W	<a href="#">BMXXBP1200H</a>	1.270/ 2.800
<b>Ruggedized Ethernet + X-bus racks</b>	BMXCPS power supply, BMEP58 processor, BMEH58 processor, I/O modules, and application-specific (counter and communication) modules	4	2.8 W	<a href="#">BMEXBP0400H</a>	0.715/ 1.576
		8	3.9 W	<a href="#">BMEXBP0800H</a>	1.070/ 2.359
		12	3.9 W	<a href="#">BMEXBP1200H</a>	1.387/ 3.058
<b>Ruggedized Ethernet + X-bus dual power supply racks</b>	BMEP58 processor, BMEH58 processor, BMXCPS400 redundant power supply, I/O modules, and application-specific (counter and communication) modules	6	3.9 W	<a href="#">BMEXBP0602H</a>	1.387/ 3.058
		10	3.9 W	<a href="#">BMEXBP1002H</a>	1.387/ 3.058

Description	Use	Reference	Weight kg/lb
<b>Ruggedized rack expansion module (3)</b>	Standard module to be installed in each rack (XBE slot) Used to daisy chain up to 4 racks	<a href="#">BMXXBE1000H</a>	0.178/ 0.392

Standard accessories for racks				
Description	For use with	Sold in lots of	Reference	Weight kg/lb
<b>Shielding connection kits</b> comprising: - 1 metal bar - 2 support bases	BM●XBP0400H rack	–	<a href="#">BMXXSP0400</a>	0.280/ 0.617
	BMXXBP0600H rack	–	<a href="#">BMXXSP0600</a>	0.310/ 0.683
	BM●XBP0800H rack BMEXBP0602H rack	–	<a href="#">BMXXSP0800</a>	0.340/ 0.750
	BM●XBP1200H rack BMEXBP1002H rack	–	<a href="#">BMXXSP1200</a>	0.400/ 0.882
	<b>Spring clamping rings</b>	Cables, cross-section 1.5...6 mm <sup>2</sup> /AWG 16...9	10	<a href="#">STBXSP3010</a>
Cables, cross-section 5...11 mm <sup>2</sup> /AWG 10...7		10	<a href="#">STBXSP3020</a>	0.070/ 0.154
<b>Protective covers</b> (replacement parts)	Unoccupied slots on BM●XBP●●00H rack	5	<a href="#">BMXXEM010</a>	0.005/ 0.011
<b>Contact protection grease 25 g</b>	Purchase one tube for every 24-slot rack	1	<a href="#">BMXGEL0025</a>	–

(1) Number of slots taking the processor module, I/O modules, and application-specific modules (excluding power supply module).

(2) Power consumption of anti-condensation resistor(s).

(3) Module and cordsets do not operate properly at temperatures lower than -25 °C/-13 °F.

# Modicon X80 modules platform

## Dedicated parts for severe environments

### Ruggedized racks and rack expansion module



Angled connector on extension cordsets

#### Standard cordsets and connection accessories

Description	Use	Composition	Type of connector	Length	Reference	Weight kg/lb
<b>X-bus extension cordsets</b> total length 30 m/ 98 ft max. (1)	Between 2 BMXXBE1000H rack expansion modules	2 x 9-way SUB-D connectors	Angled	0.8 m/ 2.63 ft	<a href="#">BMXXBC008K</a>	0.165/ 0.364
				1.5 m/ 4.92 ft	<a href="#">BMXXBC015K</a>	0.250/ 0.551
				3 m/ 9.84 ft	<a href="#">BMXXBC030K</a>	0.420/ 0.926
				5 m/ 16.4 ft	<a href="#">BMXXBC050K</a>	0.650/ 1.433
				12 m/ 39 ft	<a href="#">BMXXBC120K</a>	1.440/ 3.175
			Straight	1 m/ 3.28 ft	<a href="#">TSXCBY010K</a>	0.160/ 0.353
				3 m/ 9.84 ft	<a href="#">TSXCBY030K</a>	0.260/ 0.573
				5 m/ 16.4 ft	<a href="#">TSXCBY050K</a>	0.360/ 0.794
				12 m/ 39 ft	<a href="#">TSXCBY120K</a>	1.260/ 2.778
				18 m/ 59 ft	<a href="#">TSXCBY180K</a>	1.860/ 4.101
				28 m/ 92 ft	<a href="#">TSXCBY280KT</a> (2)	2.860/ 6.305
<b>Cable reel</b> (1)	Length of cable to be equipped with TSXCBYK9 connectors	Ends with flying leads, 2 line testers		100 m/ 328 ft	<a href="#">TSXCBY1000</a>	12.320/ 27.161



TSXTLYEX

Description	Use	Composition	Sold in lots of	Reference	Weight kg/lb
<b>Line terminator</b>	Required on both BM●XBP●●●0H modules at each end of the daisy chain	2 x 9-way SUB-D connectors marked A/ and /B	2	<a href="#">TSXTLYEX</a>	0.050/ 0.110
<b>X-bus straight connectors</b>	For ends of TSXCBY1000 cables	2 x 9-way SUB-D straight connectors	2	<a href="#">TSXCBYK9</a>	0.080/ 0.176
<b>Connector assembly kit</b>	For attaching TSXCBYK9 connectors	2 crimping pliers, 1 pen (3)	–	<a href="#">TSXCBYACC10</a>	–

(1) Module and cordsets do not operate properly at temperatures **lower than -25 °C/-13 °F**.

(2) Cable supplied with a set of 2 TSXTVSY100 electrical transient suppressors.

(3) To attach the connectors to the cable, you also need a wire stripper, a pair of scissors, and a digital ohmmeter.



# Modicon X80 modules platform

Dedicated parts for severe environments  
Ruggedized discrete I/O modules



BMXD1160H

## References

### Ruggedized discrete input modules

Type of current	Input voltage	Connection via (1)	IEC/EN 61131-2 conformity	No. of channels (common)	Reference	Weight kg/lb
DC	24 V (positive logic)	Screw or spring-type 20-way removable terminal block	Type 3	16 isolated inputs (1 x 16)	<a href="#">BMXDDI1602H</a>	0.115/ 0.254
		One 40-way connector	Type 3	32 isolated inputs (2 x 16)	<a href="#">BMXDDI3202KH</a>	0.110/ 0.243
		Two 40-way connectors	Non-IEC	64 isolated inputs (4 x 16)	<a href="#">BMXDDI6402KH</a>	0.145/ 0.320
DC	24 V (negative logic)	Screw or spring-type 20-way removable terminal block	Non-IEC	16 isolated inputs (1 x 16)	<a href="#">BMXDAI1602H</a>	0.115/ 0.254
	48 V (positive logic)	Screw or spring-type 20-way removable terminal block	Type 1	16 isolated inputs (1 x 16)	<a href="#">BMXDDI1603H</a>	0.115/ 0.254
AC	24 V	Screw or spring-type 20-way removable terminal block	Type 1	16 isolated inputs (1 x 16)	<a href="#">BMXDAI1602H</a>	0.115/ 0.254
		Screw or spring-type 20-way removable terminal block	Type 3	16 isolated inputs (1 x 16)	<a href="#">BMXDAI1603H</a>	0.115/ 0.254
	48 V	Screw or spring-type 20-way removable terminal block	Type 3	16 isolated inputs (1 x 16)	<a href="#">BMXDAI1603H</a>	0.115/ 0.254
		Screw or spring-type 20-way removable terminal block	Type 3	16 isolated inputs (1 x 16)	<a href="#">BMXDAI1604H</a>	0.115/ 0.254
	200...240 V	Caged or spring-type 40-way removable terminal block	Type 1	16 isolated inputs (1 x 16)	<a href="#">BMXDAI1614H</a>	0.150/ 0.331
	Caged or spring-type 40-way removable terminal block	Type 1	16 isolated inputs (1 x 16)	<a href="#">BMXDAI1615H</a>	0.156/ 0.344	



BMXDDO162H BMXDRA0815H/0805H/1605H

### Ruggedized discrete output modules

Type of current	Output voltage	Connection via (1)	IEC/EN 61131-2 conformity	No. of channels (common)	Reference	Weight kg/lb
DC transistor	24 V/0.5 A (positive logic)	Screw or spring-type 20-way removable terminal block	Yes	16 protected outputs (1 x 16)	<a href="#">BMXDDO1602H</a>	0.120/ 0.265
		Screw or spring-type 20-way removable terminal block	Yes	16 protected outputs (1 x 16)	<a href="#">BMXDDO1612H</a>	0.120/ 0.265
	24 V/0.1 A (positive logic)	One 40-way connector	Yes	32 protected outputs (2 x 16)	<a href="#">BMXDDO3202KC</a>	0.110/ 0.243
		Two 40-way connectors	Yes	64 protected outputs (4 x 16)	<a href="#">BMXDDO6402KC</a>	0.150/ 0.331
AC triac	100...240 V	Screw or spring-type 20-way removable terminal block	Yes	16 outputs (4 x 4)	<a href="#">BMXDAO1605H</a>	0.140/ 0.309
	24...240 V	Caged or spring-type 40-way removable terminal block	Yes	16 isolated outputs	<a href="#">BMXDAO1615H</a>	0.250/ 0.551
DC or AC relay	12...24 V DC/2 A	Screw or spring-type 20-way removable terminal block	Yes	8 non-protected outputs (without common)	<a href="#">BMXDRA0805H</a>	0.145/ 0.320
			Yes	8 normally open isolated relay outputs	<a href="#">BMXDRA0815H</a>	0.210/ 0.463
	24 V DC/2 A, 240 V AC/2 A	Screw or spring-type 20-way removable terminal block	Yes	16 non-protected outputs (2 x 8)	<a href="#">BMXDRA1605H</a>	0.150/ 0.331
			Yes	8 normally open/ normally closed isolated relay outputs	<a href="#">BMXDRC0805H</a>	0.189/ 0.417
	24...240 V AC/2 A	Caged or spring-type 40-way removable terminal block	Yes	8 normally open/ normally closed isolated relay outputs		

### Ruggedized mixed discrete I/O modules

Number of I/O	Connection via (1)	No. of input channels (common)	No. of output channels (common)	IEC/EN 61131-2 conformity	Reference	Weight kg/lb
16	Screw or spring-type 20-way removable terminal block	8 (positive logic) (1 x 8)	8, transistor 24 V DC/0.5 A (1 x 8)	Inputs, type 3	<a href="#">BMXDDM16022H</a>	0.115/ 0.254
			8, 24 V DC or 24...240 V AC relay (1 x 8)	Inputs, type 3	<a href="#">BMXDDM16025H</a>	0.135/ 0.298



BMXDDM1602H

### Standard removable connection blocks

Description	Use	Type	Reference	Weight kg/lb
20-way removable terminal blocks	For module with 20-way removable terminal block	Caged	<a href="#">BMXFTB2000</a>	0.093/ 0.205
		Screw clamp	<a href="#">BMXFTB2010</a>	0.075/ 0.165
		Spring-type	<a href="#">BMXFTB2020</a>	0.060/ 0.132
40-way removable terminal blocks (with gold plating)	For hardened version of module only with 40-way removable terminal block	Caged	<a href="#">BMXFTB4000H</a>	0.166/ 0.366
		Spring	<a href="#">BMXFTB4020H</a>	0.098/ 0.216



BMXFTB2000

(1) By connector, module supplied with cover(s)



BMXAMI0410H BMEAH10812H



BMXART0414H



BMEAH00412C BMXAMO0802H



BMXFTW01



BMXFTW05



BMXFCW01



BMXFCW03

### References

#### Ruggedized analog input modules

Type of inputs	Input signal range	Resolution	Connection	No. of channels	Reference	Weight kg/lb	
Isolated high-level inputs	± 10 V, 0...10 V, 0...5 V, 1...5 V, ± 5 V, 0...20 mA, 4...20 mA	16 bits	Via caged, screw clamp, or spring-type removable terminal block	4 high-speed channels	<a href="#">BMXAMI0410H</a>	0.143/0.315	
			Via caged or spring-type removable terminal block	8 isolated high-speed channels	<a href="#">BMXAMI0810H</a>	0.175/0.386	
Isolated low-level inputs	Temperature probe, thermocouple, ± 40 mV, ± 80 mV, ± 160 mV, ± 320 mV, ± 640 mV, ± 1.28 V	15 bits + sign	Via caged, screw clamp, or spring-type removable terminal block	4...20 mA	8 isolated high-speed channels	<a href="#">BMEAH10812H</a>	0.233/0.514
				40-way connector	4 channels	<a href="#">BMXART0414H</a>	0.135/0.298
				8 channels	<a href="#">BMXART0814H</a>	0.165/0.364	

#### Ruggedized analog output module

Type of outputs	Output signal range	Resolution	Connection	No. of channels	Reference	Weight kg/lb
Isolated high-level outputs	± 10 V, 0...20 mA, 4...20 mA	16 bits	Via caged, screw clamp, or spring-type removable terminal block	2 channels	<a href="#">BMXAMO0210H</a>	0.144/0.317
				4 channels	<a href="#">BMXAMO0410H</a>	0.175/0.386
				4 channels	<a href="#">BMEAH00412C</a>	0.223/0.492
Non-isolated high-level outputs	0...20 mA, 4...20 mA	15 bits + sign	Via caged, screw clamp, or spring-type removable terminal block	4 channels	<a href="#">BMXAMO0802H</a>	0.150/0.331

#### Ruggedized mixed analog I/O module

Type of outputs	Signal range	Resolution	Connection	No. of channels	Reference	Weight kg/lb
Mixed I/O, non-isolated	± 10 V, 0...10 V, 0...5 V, 1...5 V, 0...20 mA, 4...20 mA	14 bits or 12 bits depending on the range	Via caged, screw clamp, or spring-type removable terminal block	I: 4 channels Q: 2 channels	<a href="#">BMXAMM0600H</a>	0.155/0.342

#### Standard preformed cordsets for I/O modules with removable terminal block (for ruggedized discrete I/O modules)

Description	Composition	Length m/ft	Reference	Weight kg/lb
Preassembled cordsets with one end with flying leads	One spring-type 20-way removable terminal block (BMXFTB2020). One end with color-coded flying leads	3/9.84	<a href="#">BMXFTW301</a>	0.850/1.874
		5/16.4	<a href="#">BMXFTW501</a>	1.400/3.086
		10/32	<a href="#">BMXFTW1001</a>	2.780/6.129
Preassembled cordsets with one end with flying leads	One spring-type 40-way removable terminal block (BMXFTB4020). One end with color-coded flying leads	3/9.84	<a href="#">BMXFTW305</a>	0.940/2.072
		5/16.4	<a href="#">BMXFTW505</a>	1.460/3.219

#### Preassembled cordsets for 32- and 64-channel I/O modules with 40-way connectors (for ruggedized analog I/O modules)

Description	Composition	Length m/ft	Reference	Weight kg/lb
Preassembled cordsets with one end with flying leads	One 40-way connector. One end with color-coded flying leads	3/9.84	<a href="#">BMXFCW301</a>	0.820/1.808
		5/16.4	<a href="#">BMXFCW501</a>	1.370/3.020
		10/33	<a href="#">BMXFCW1001</a>	2.770/6.107
Preassembled cordsets with one end with flying leads	One 40-way connector. Two ends with color-coded flying leads	3/9.84	<a href="#">BMXFCW303</a>	0.900/1.984
		5/16.4	<a href="#">BMXFCW503</a>	1.490/3.285
		10/33	<a href="#">BMXFCW1003</a>	2.960/6.526

# Modicon X80 modules platform

Dedicated parts for severe environments  
Accessories for ruggedized I/O modules

## References

### Standard connection accessories for analog modules (1)

Description	For use with modules	Type, composition	Length	Reference	Weight kg/lb
20-way removable terminal blocks	BMXAMI0410H	Caged	–	<a href="#">BMXFTB2000</a>	0.093/ 0.205
	BMXAMO0210H	Screw clamp	–	<a href="#">BMXFTB2010</a>	0.075/ 0.165
	BMXAMM0600H				
	BMEAHIO812H	Spring	–	<a href="#">BMXFTB2020</a>	0.060/ 0.132
	BMEAHO0412C				
BMXAMO0802H					
28-way removable terminal blocks	BMXAMI0810H	Caged	–	<a href="#">BMXFTB2800</a>	0.111/ 0.245
		Spring	–	<a href="#">BMXFTB2820</a>	0.080/ 0.176
Preassembled cordsets	BMXAMI0410H	One 20-way removable terminal block (BMXFTB2020). One end with color-coded flying leads	3 m/ 9.84 ft	<a href="#">BMXFTW301S</a>	0.470/ 1.036
	BMXAMO0210H				
	BMXAMM0600H	One 28-way spring-type removable terminal block (BMXFTB2820). One end with color-coded flying leads	5 m/ 16.4 ft	<a href="#">BMXFTW501S</a>	0.700/ 1.543
	BMEAHIO812H				
	BMEAHO0412C				
	BMXAMO0802H	One 40-way connector. One end with color-coded flying leads	3 m/ 9.84 ft	<a href="#">BMXFCW301S</a>	0.480/ 1.058
	BMXAMO0410H				
	BMXAMI0810H	One 40-way connector. One end with color-coded flying leads	5 m/ 16.4 ft	<a href="#">BMXFCW501S</a>	0.710/ 1.565
BMXART0814H (2)					



BMXFTW01S



ABE7CPA41

### Modicon Telefast ABE7 pre-wired system (3)

Modicon Telefast ABE7 sub-bases	BMXAMO0210H	Direct screw-type connection of 2/4 inputs	–	<a href="#">ABE7CPA21</a>	0.210/ 0.463
	BMXAMO0410H				
	BMEAHO0412C	Point-to-point screw-type connection of 8 I/O	–	<a href="#">ABE7CPA02</a>	0.317/ 0.699
	BMXAMI0810H				
	BMEAHIO812H				
BMXAMO0802H	Direct connection of 8 inputs. Delivers 8x 24 V $\bar{\bar{c}}$ power supplies limited to 25 mA to the 8 current inputs	–	<a href="#">ABE7CPA03</a>	0.307/ 0.677	
BMEAHIO812H					
Preformed cordsets for Modicon Telefast ABE7 sub-bases	BMXAMI0410H	Distribution of isolated power supplies. Delivers 4 protected isolated power supplies for 4...20 mA inputs. Direct connection of 4 inputs	–	<a href="#">ABE7CPA410</a>	0.180/ 0.397
	BMXAMO0210H				
	BMXAMO0410H	Connection and provision of cold-junction compensation for thermocouples. Direct connection of 4 inputs	–	<a href="#">ABE7CPA412</a>	0.180/ 0.397
	BMEAHO0412C				
	BMXAMO0802H				
	BMXART0414H	One 20-way removable terminal block and one 25-way SUB-D connector for ABE7CPA410/CPA21 sub-base	1.5 m/ 4.92 ft	<a href="#">BMXFCA150</a>	0.320/ 0.705
	BMXART0814H				
	BMXART0814H	One 40-way connector and one 25-way SUB-D connector for ABE7CPA412 sub-base	3 m/ 9.84 ft	<a href="#">BMXFCA300</a>	0.500/ 1.102
			5 m/ 16.4 ft	<a href="#">BMXFCA500</a>	0.730/ 1.609
			1.5 m/ 4.92 ft	<a href="#">BMXFCA152</a>	0.330/ 0.728
3 m/ 9.84 ft			<a href="#">BMXFCA302</a>	0.510/ 1.124	
BMEAHIO812H	One 20-way removable terminal block and one 25-way SUB-D connector for ABE7CPA02/CPA03 sub-base	5 m/ 16.4 ft	<a href="#">BMXFCA502</a>	0.740/ 1.631	
		1.5 m/ 4.92 ft	<a href="#">BMXFCA152</a>	0.320/ 0.705	
BMXAMO0802H	One 20-way removable terminal block and one 25-way SUB-D connector for ABE7CPA02 sub-base	3 m/ 9.84 ft	<a href="#">BMXFCA302</a>	0.500/ 1.102	
		1.5 m/ 4.92 ft	<a href="#">BMXFCA152</a>	0.374/ 0.825	
		3 m/ 9.84 ft	<a href="#">BMXFCA302</a>	0.500/ 1.102	



BMXFCA000



BMXFCA002

(1) The shielding on the cordsets carrying the analog signals must always be connected to the [BMXXSP0000](#) shielding connection kit mounted under the rack holding the analog modules (see [page 2/3](#)).

(2) The [BMXART0814H](#) 8-channel module requires two [ABE7CPA412](#) sub-bases and two [BMXFCA002](#) cordsets.

(3) When using Modicon Telefast pre-wired system in corrosive atmosphere, apply a protective coating of grease to connectors and terminal blocks.

# Modicon X80 modules platform

Dedicated parts for severe environments  
Ruggedized communication modules



BMXNOE0100H/0110H



BMXNOM0200H

## Communication

### BMXNOE0100H/0110H ruggedized Ethernet communication modules

Description	Data rate	Transparent Ready class	Reference	Weight kg/lb
Ethernet Modbus/TCP network modules	10/100 Mbps	B30	<a href="#">BMXNOE0100H</a>	0.200/ 0.441
		C30	<a href="#">BMXNOE0110H</a>	0.200/ 0.441

### BMXNOM0200H ruggedized serial link module

Description	Protocol	Physical layer	Reference	Weight kg/lb
Serial link module (2 channels)	Modbus master/slave RTU/ASCII, Character mode, GSM/GPRS modem	1 non-isolated RS 232 channel (SL0)	<a href="#">BMXNOM0200H</a>	0.230/ 0.507
		2 isolated RS 485 channels (SL0 and SL1)		



BMXNOR0200H

### BMXNOR0200H ruggedized RTU communication module

Description	Protocols	Physical layer	Reference	Weight kg/lb
RTU communication module	Modbus TCP, IEC 60870-5-104, or DNP3 IP (client or server)	1 Ethernet port 10BASE-T/100BASE-TX	<a href="#">BMXNOR0200H</a>	0.205/ 0.452
		IEC 60870-5-101 or DNP3 serial (master or slave)		



BMENOR2200H

### BMENOR2200H ruggedized Advanced RTU communication module

Description	Protocols	Physical layer	Reference	Weight kg/lb
Advanced RTU communication module	DNP3 SAv2/SAv5, Modbus TCP, SNMP, HTTPS, Sntp (Client or Server)	1 Ethernet port 100BASE-TX (2)	<a href="#">BMENOR2200H</a>	0.380/ 0.837
		IEC 60870-5-101 or DNP3 serial (master or slave) (1)		



BMXNRP0200C

### BMXNRP0200C/0201C "Conformal Coating" EIO drop fiber optic repeaters (3) (4)

Description	Optical fiber	Reference	Weight kg/lb
Modicon X80 EIO drop fiber optic repeaters	Multimode	<a href="#">BMXNRP0200C</a>	-
	Single-mode	<a href="#">BMXNRP0201C</a>	-



BMECXM0100H



PMEPXM0100H

### BMECXM0100H ruggedized communication module

Description	Protocols	Physical layer	Reference	Weight kg/lb
CANopen communication module	CiA 301 V4.2 standard (master or slave); Ethernet/IP	ISO 11898 (9-way SUB-D connector)	<a href="#">BMECXM0100H</a>	0.200/ 0.441

### PMEPXM0100H ruggedized communication module

Description	Protocols	Physical layer	Reference	Weight kg/lb
Hardened X80 Profibus DP Master module	Implicit exchange of process data	EIA-485 (optical, MBP)	<a href="#">PMEPXM0100H</a>	0.270/ 0.595

(1) Not implemented yet.

(2) On backplane port.

(3) Requires Unity Pro Extra Large software ≥ V7.0; see our website [www.schneider-electric.com](http://www.schneider-electric.com).

(4) Supports operation at -25 to 60°C / -13 to 140°F.

# Modicon X80 modules platform

Dedicated parts for severe environments  
Ruggedized communication modules and network gateway



BMECRA31210



BMXCRA31210



BMENOC0321C



BMENOS0300C



BMENOP0300C



TCSEGPA23F14FK

## Communication

### “Conformal Coating” EIO drop adapters

Description	SERVICE port	Reference	Weight kg/lb
Modicon X80 EIO drop adapter for Ethernet + X-bus racks	1	<a href="#">BMECRA31210C</a>	–
Modicon X80 EIO performance drop adapter	1	<a href="#">BMXCRA31210C</a>	–

### “Conformal Coating” Ethernet network option switch

Description	SERVICE port	Device network port (Ethernet)	Reference	Weight kg/lb
EtherNet/IP, Modbus/TCP network module	1	2	<a href="#">BMENOC0301C</a>	0.345/ 0.761
FactoryCast network module	1	2	<a href="#">BMENOC0311C</a>	0.345/ 0.761
NOC control network module	1	2	<a href="#">BMENOC0321C</a>	0.345/ 0.761

### “Conformal Coating” Ethernet network option switch

Description	SERVICE port	Device network port (Ethernet)	Reference	Weight kg/lb
Ethernet network option switch	1	2	<a href="#">BMENOS0300C</a>	–

### “Conformal Coating” IEC 61850 communication module

Description	Protocols	Physical layer	Reference	Weight kg/lb
IEC 61850 communication module	IEC 61850 standard	10BASE-T/ 100BASE-TX	<a href="#">BMENOP0300C</a>	0.345/ 0.761

### Ruggedized Profibus DP network gateway

Description	Protocols	Physical layer	Reference	Weight kg/lb
Profibus Remote Master (PRM) module	Modbus TCP	1 Ethernet switch, 2 ports 10BASE-T/ 100BASE-TX	<a href="#">TCSEGPA23F14FK</a>	–
	Profibus DP V1 and Profibus PA (via gateway)	1 isolated RS 485 Profibus DP port		

### Standard connection accessory

Designation	Description	RS 232 interface	Reference	Weight kg/lb
Cordset for DCE terminal (modem, etc.)	Equipped with 1 x RJ45 connector and 1 x 9-way male SUB-D connector Length 3 m/9.84 ft	Simplified 4-wire (RX, TX, RTS, and CTS)	<a href="#">TCSMCN3M4M3S2</a>	0.150/ 0.331
		Full 8-wire (except RI signal)	<a href="#">TCSXCN3M4F3S4</a>	0.165/ 0.364

# Modicon X80 modules platform

Dedicated parts for severe environments  
Ruggedized application-specific modules



BMXEHC0200H



BMXEHC0800H



BMXETM0200H



BMXEAE0300H



BMXERT1604H

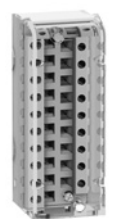

BMXFTB20-0

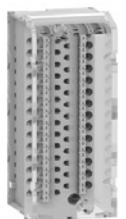

BMXFTB28-0

## Application-specific modules

### BMXEHC0200H/0800H ruggedized counter modules

Description	No. of channels	Characteristics	Reference	Weight kg/lb
<b>Counter modules</b> for 24 V $\pm$ 2- and 3-wire sensors and 10/30 V $\pm$ incremental encoders with push-pull outputs	2	60 kHz counting	<a href="#">BMXEHC0200H</a>	0.112/ 0.247
	8	10 kHz counting	<a href="#">BMXEHC0800H</a>	0.113/ 0.249

### BMXETM0200H ruggedized frequency input module

Description	No. of channels	Characteristics	Reference	Weight kg/lb
<b>Speed and frequency control module for turbomachinery application</b>	2	Input frequency: 0...500Hz, reflex digital output	<a href="#">BMXETM0200H</a>	0.124/ 0.273

### BMXEAE0300H ruggedized SSI encoder interface module

Description	No. of channels	Characteristics	Reference	Weight kg/lb
SSI encoder interface module	3	8- to 31-bit data width 4 baud rates: 100 kHz, 200 kHz, 500 kHz, 1 MHz	<a href="#">BMXEAE0300H</a>	0.138/ 0.304

### BMXERT1604H ruggedized time stamping module

Description	No. of channels	Characteristics	Reference	Weight kg/lb
Multifunction time stamping input module	16	Time- and date-stamping at 1 ms 1.6 < resolution < 3.3 ms 400 events (1) 16 discrete inputs on module	<a href="#">BMXERT1604H</a>	0.119/ 0.262

### Standard connection accessories (2)

Description	Composition	Unit reference	Weight kg/lb
<b>Connector kit</b> for BMXEHC0200H module	Two 16-way connectors and one 10-way connector	<a href="#">BMXXTSHSC20</a>	0.021/ 0.046
<b>20-way removable terminal blocks</b> for BMXEHC0800H module	Caged	<a href="#">BMXFTB2000</a>	0.093/ 0.205
	Screw clamp	<a href="#">BMXFTB2010</a>	0.075/ 0.165
	Spring	<a href="#">BMXFTB2020</a>	0.060/ 0.132
<b>28-way removable terminal blocks</b> for BMXEAE0300H and BMXERT1604H module	Caged	<a href="#">BMXFTB2800</a>	0.111/ 0.245
	Spring	<a href="#">BMXFTB2820</a>	0.080/ 0.176
<b>Shielding connection kits</b> for BMXEHC0200H/0800H and BMXEAE0300H modules	Comprising a metal bar and 2 support bases for mounting on rack	<a href="#">See page 2/5</a>	–

(1) This maximum value is not an absolute value. It depends on the overall system dynamics (total number of scanned items and number of events generated by the system).

(2) The shielding on the cordsets carrying the counter signals must always be connected to the **BMXXSP-000** shielding connection kit mounted under the rack holding the **BMXEHC0200H** module (see [page 2/3](#)).



# 7 - Compatibility with OsiSense XU/XS

---

## Compatibility with sensors

- OsiSense XU photoelectric sensors ..... [page 7/2](#)
- OsiSense XS inductive proximity sensors ..... [page 7/4](#)



# Modicon X80 modules platform

## Inputs and OsiSense XU photoelectric sensors

Photoelectric sensors				⋮ inputs, BMXDDI					⋮ inputs, BMXDDM			⋮ inputs, BMXAMI		~ inputs, BMXDAI						
Type	Reference			1602	1603	1604T	3202K	6402K	16022	16025	3202K	0810	0800	1602	1603	1604	0805	0814		
<b>General purpose</b>																				
Design Ø 18	Metal	3-wire, PNP 24V	XUB0/1/2/4/5/9B●P●●●																	
		3-wire, NPN 24V	XUB0/1/2/4/5/9B●N●●●																	
	Plastic	3-wire, PNP 24V	XUB0/1/2/4/5/9A●P●●●																	
		3-wire, NPN 24V	XUB0/1/2/4/5/9A●N●●●																	
Design	Miniature	3-wire, PNP 24V	XUM0/2/5/9AP●●●●																	
		3-wire, NPN 24V	XUM0/2/5/9AN●●●●																	
	Compact 50x50	3-wire, PNP 24V	XUK1/2/5/8/9AP●●●																	
		3-wire, NPN 24V	XUK1/2/5/8/9AN●●●																	
		3-wire, programmable PNP/NPN DC	XUK0AK●●●																	
		5-wire, programmable AC/DC	XUK0/1/2/5/8/9AR																	
		Compact 92x71	3-wire, programmable PNP/NPN DC	XUX0/1/2/5/8/9AK																
			5-wire, programmable AC DC	XUX0/1/2/5/8/9AR																
<b>Application</b>																				
Material handling	Optical fork	3-wire, PNP 24V	XUVR●●●●P●●																	
		3-wire, NPN 24V	XUVR●●●●N●●																	
		3-wire, PNP 24V	XUVA●●●●P●●																	
		3-wire, NPN 24V	XUVA●●●●N●●																	
		4-wire, PNP, or NPN 24V	XUYF●●●●●																	
		4-wire, PNP, or NPN 24V	XUVU06●●●																	
		4-wire, PNP, or NPN 24V	XUVK●●●																	
		3-wire, PNP 24V	XUVH●●●																	
		3-wire, NPN 24V	XUVJ●●●																	
		4-wire, PNP, or NPN 24V	XUVF●●●																	
Packaging	Fiber	4-wire, PNP, or NPN 24V	XUYDCF●●●																	
	Compact	4-wire, PNP, or NPN 24V	XUK●S●●●●																	
	M 18, threaded	3-wire, PNP 24V	XU5M18U1D																	
		Fiber	4-wire, PNP, or NPN 24V	XUYAFL●●●																
	M 18, threaded	3-wire, PNP 24V	XUBT●P●●●																	
		3-wire, NPN 24V	XUBT●N●●●																	
	Compact	4-wire, PNP, or NPN 24V	XUKT●●●																	
		3-wire, PNP 24V	XUKC1N●●●																	
		3-wire, NPN 24V	XUKC1P●●●																	
		3-wire, PNP 24V	XURC3P●●●																	
		3-wire, NPN 24V	XURC3N●●●																	
		4-wire, PNP, or NPN 24V	XUMW●●●																	
	M 18, threaded	3-wire, PNP 24V	XUB0SP●●●																	
		3-wire, NPN 24V	XUB0SN●●●																	
		3-wire, PNP 24V	XU●N18P●●●																	
		3-wire, NPN 24V	XU●N18N●●●																	
	M 8, threaded	3-wire, PNP 24V	XUAH●●●																	
		3-wire, NPN 24V	XUAJ●●●																	
	Miniature	3-wire, PNP 24V	XUYP●●●●P●●																	
		3-wire, NPN 24V	XUYP●●●●N●●																	
3-wire, PNP 24V		XUM2/5/9BP●●●																		
3-wire, NPN 24V		XUM2/5/9BN●●●																		
3-wire, PNP 24V		XUY●●●929●●																		
Hoisting	M 18, threaded	3-wire, PNP 24V	XUBLBP●●●																	
		3-wire, NPN 24V	XUBLBN●●●																	
	Compact	2-wire 4...20 mA; 3-wire 0...10V	XUJK803538																	
	M 18, threaded	2-wire 4...20 mA	XU5M18AB20D																	
		PNP, 2-wire 4...20 mA	XU2M18AB20D																	
	Compact	PNP, 2-wire 4...20 mA	XUYP●●●925																	
		4-wire, PNP, or NPN 24V	XUYPS●●●																	
	Fiber	3-wire, PNP 24V	XUDA●P●●●																	
		3-wire, NPN 24V	XUDA●N●●●																	
		4-wire, PNP, or NPN 24V	XUYAF●●●																	
	Other formats	3-wire, programmable PNP/NPN DC	XUC2/8/9AK●●●																	
		5-wire, programmable AC/DC	XUC2/8/9ARC●●●																	
		3-wire, NPN 24V + analog	XUE●AA●●●																	
		2-wire, AC	XULA●●●																	
		5-wire, programmable AC/DC	XULM●●●																	
3-wire, programmable PNP/NPN DC		XUYB●●●S																		
5-wire, programmable AC/DC		XUYB●●●R																		
M 18, threaded	2-wire, AC/DC	XU5/8/9M18MA●●●																		

Compatible  
Incompatible

# Modicon X80 modules platform

## Inputs and OsiSense XS inductive proximity sensors

Proximity sensors				⏏ inputs, BMXDDI						⏏ inputs, BMXDDM			⏏ inputs, BMXAMI		~ inputs, BMXDAl				
Type	Reference			1602	1603	1604T	3202K	6402K	16022	16025	3202K	0810	0800	1602	1603	1604	0805	0814	
<b>General purpose</b>																			
Cylindrical, flush, standard sensing distance, short barrel	Ø 6.5 plain short	3-wire, PNP 24V	XS506B1P●●●																
		3-wire, NPN 24V	XS506B1N●●●																
		2-wire, DC 24V	XS506BSC●●●																
	M8, threaded short	3-wire, PNP 24V	XS508B1P●●●																
		3-wire, NPN 24V	XS508B1N●●●																
		2-wire, DC 24V	XS508BSC●●●																
	M12, threaded short	3-wire, PNP 24V	XS512B1P●●●																
		3-wire, NPN 24V	XS512B1N●●●																
		2-wire, DC 24V	XS512BSD/C●●●																
	M18, threaded short	3-wire, PNP 24V	XS518B1P●●●																
		3-wire, NPN 24V	XS518B1N●●●																
		2-wire, DC 24V	XS518BSD/C●●●																
M30, threaded short	3-wire, PNP 24V	XS530B1P●●●																	
	3-wire, NPN 24V	XS530B1N●●●																	
	2-wire, DC 24V	XS530BSD/C●●●																	
Cylindrical, flush, standard sensing distance, long barrel	M8, threaded long	3-wire, PNP 24V-48V	XS508BLP●●●																
		3-wire, NPN 24V-48V	XS508BLN●●●																
		2-wire, DC 24V-48V	XS508B1D/C●●●																
	M12, threaded long	3-wire, PNP 24V-48V	XS512BLP●●●																
		3-wire, NPN 24V-48V	XS512BLN●●●																
		2-wire, DC 24V-48V	XS512B1D/C●●●																
	M18, threaded long	3-wire, PNP 24V-48V	XS518BLP●●●																
		3-wire, NPN 24V-48V	XS518BLN●●●																
		2-wire, DC 24V-48V	XS518B1D/C●●●																
	M30, threaded long	3-wire, PNP 24V-48V	XS530BLP●●●																
		3-wire, NPN 24V-48V	XS530BLN●●●																
		2-wire, DC 24V-48V	XS530B1D/C●●●																
M12, threaded long	2-wire, AC/DC	XS512B1M●●●																	
M18, threaded long	2-wire, AC/DC	XS518B1M●●●																	
M30, threaded long	2-wire, AC/DC	XS530B1M●●●																	
Cylindrical, flush, extended sensing distance, short barrel	Ø 6.5 plain short	3-wire, PNP 24V	XS106B3P●●●																
		3-wire, NPN 24V	XS106B3N●●●																
		2-wire, DC 24V	XS606B3C●●●																
	M8, threaded short	3-wire, PNP 24V	XS108B3P●●●																
		3-wire, NPN 24V	XS108B3N●●●																
		2-wire, DC 24V	XS608B3C●●●																
	M12, threaded short	3-wire, PNP 24V	XS112B3P●●●																
		3-wire, NPN 24V	XS112B3N●●●																
		2-wire, DC 24V	XS612B3D●●●																
	M18, threaded short	3-wire, PNP 24V	XS118B3P●●●																
		3-wire, NPN 24V	XS118B3N●●●																
		2-wire, DC 24V	XS618B3D●●●																
M30, threaded short	3-wire, PNP 24V	XS130B3P●●●																	
	3-wire, NPN 24V	XS130B3N●●●																	
	2-wire, DC 24V	XS630B3D●●●																	
Cylindrical, flush, extended sensing distance, long barrel	M8, threaded long	3-wire, PNP 24V-48V	XS608B1P●●●																
		3-wire, NPN 24V-48V	XS608B1N●●●																
		2-wire, DC 24V-48V	XS608B1D●●●																
	M12, threaded long	3-wire, PNP 24V-48V	XS612B1P●●●																
		3-wire, NPN 24V-48V	XS612B1N●●●																
		2-wire, DC 24V-48V	XS612B1D●●●																
	M18, threaded long	3-wire, PNP 24V-48V	XS618B1P●●●																
		3-wire, NPN 24V-48V	XS618B1N●●●																
		2-wire, DC 24V-48V	XS618B1D●●●																
	M30, threaded long	3-wire, PNP 24V-48V	XS630B1P●●●																
		3-wire, NPN 24V-48V	XS630B1N●●●																
		2-wire, DC 24V-48V	XS630B1D●●●																
M12, threaded long	2-wire, AC/DC	XS612B1M●●●																	
M18, threaded long	2-wire, AC/DC	XS618B1M●●●																	
M30, threaded long	2-wire, AC/DC	XS630B1M●●●																	
Cylindrical, non flush, extended sensing distance, long barrel	M12, threaded long	3-wire, PNP 24V-48V	XS612B4P●●●																
		3-wire, NPN 24V-48V	XS612B4N●●●																
		3-wire, PNP 24V-48V	XS618B4P●●●																
	M18, threaded long	3-wire, NPN 24V-48V	XS618B4N●●●																
		3-wire, PNP 24V-48V	XS630B4P●●●																
		3-wire, NPN 24V-48V	XS630B4N●●●																
	M30, threaded long	3-wire, PNP 24V-48V	XS630B4M●●●																
		3-wire, NPN 24V-48V	XS630B4N●●●																
		2-wire, AC/DC	XS612B4M●●●																
	M18, threaded long	2-wire, AC/DC	XS618B4M●●●																
	M30, threaded long	2-wire, AC/DC	XS630B4M●●●																

Compatible  
Incompatible

# Modicon X80 modules platform

## Inputs and OsiSense XS inductive proximity sensors (continued)

Proximity sensors			∩ inputs, BMXDDI					∩ inputs, BMXDDM			∩ inputs, BMXAMI		~ inputs, BMXDAI							
Type	Reference		1602	1603	1604T	3202K	6402K	16022	16025	3202K	0810	0800	1602	1603	1604	0805	0814			
<b>General purpose</b>																				
Flat, flush mountable, standard sensing distance	Format J 8x22x8	3-wire, PNP 24V	XS7J1A1P●●●																	
		3-wire, NPN 24V	XS7J1A1N●●●																	
		2-wire, DC 24V	XS7J1A1D●●●																	
		Format F 15x22x8	3-wire, PNP 24V	XS7F1A1P●●●																
			3-wire, NPN 24V	XS7F1A1N●●●																
			2-wire, DC 24V	XS7F1A1D●●●																
	Format E 26x26x13	3-wire, PNP 24V	XS7E1A1P●●●																	
		3-wire, NPN 24V	XS7E1A1N●●●																	
		2-wire, DC 24V	XS7E1A1D/C●●●																	
	Format C 40x40x15	3-wire, PNP 24V	XS7C1A1P●●●																	
		3-wire, NPN 24V	XS7C1A1N●●●																	
		2-wire, DC 24V	XS7C1A1D/C●●●																	
Format D 80x80x26	3-wire, PNP 24V	XS7D1A1P●●●																		
	3-wire, NPN 24V	XS7D1A1N●●●																		
	2-wire, DC 24V	XS7D1A1D/C●●●																		
Format 40x40x70 and 40x40x117 Plastic, with turret head: 5 positions	NO + NC	4-wire, PNP 24V-48V	XS7/XS8C2/C4A1/A4P●●●																	
	NO/NC programmable	4-wire, NPN 24V-48V	XS7/XS8C2/C4A1/A4N●●●																	
		2-wire, DC 24V-48V	XS7/XS8C2/C4A1/A4D●●●																	
		2-wire, AC/DC	XS7/XS8C2/C4A1/A4M●●●																	
Flat, flush mountable, extended sensing distance	Format E 26x26x13	3-wire, PNP 24V	XS8E1A1P●●●																	
		3-wire, NPN 24V	XS8E1A1N●●●																	
		2-wire, AC/DC	XS8E1A1M●●●																	
	Format C 40x40x15	3-wire, PNP 24V	XS8C1A1P●●●																	
		3-wire, NPN 24V	XS8C1A1N●●●																	
		2-wire, AC/DC	XS8C1A1M●●●																	
	Format D 80x80x26	3-wire, PNP 24V	XS8D1A1P●●●																	
		3-wire, NPN 24V	XS8D1A1N●●●																	
		2-wire, AC/DC	XS8D1A1M●●●																	
Cylindrical multi-voltage	M12, threaded	2-wire, AC/DC	XS1/2M12M●250																	
	M18, threaded	2-wire, AC/DC	XS1/2M18M●250																	
	M30, threaded	2-wire, AC/DC	XS1/2M30M●250																	
Cylindrical metal, 4-wire	Ø 6.5, plain	4-wire, PNP 24V	XS1L06PC410																	
		4-wire, NPN 24V	XS1L06NC410																	
		M8, threaded	4-wire, PNP 24V	XS1/2M08PC410●																
	M12, threaded	4-wire, NPN 24V	XS1/2M08NC410●																	
		4-wire, PNP 24V	XS1/2N12PC410●																	
		4-wire, NPN 24V	XS1/2N12NC410●																	
		4-wire, PNP 24V	XS1/2N18PC410●																	
	M18, threaded	4-wire, NPN 24V	XS1/2N18NC410●																	
		4-wire, PNP 24V	XS1/2N30PC410●																	
		4-wire, NPN 24V	XS1/2N30NC410●																	
Cylindrical metal, 4-wire PNP + NPN	M12, threaded	4-wire, PNP+NPN, prog. 24V	XS1/2/4M12KP340●																	
	M18, threaded	4-wire, PNP+NPN, prog. 24V	XS1/2/4M18KP340●																	
	M30, threaded	4-wire, PNP+NPN, prog. 24V	XS1/2/4M30KP340●																	
Cylindrical plastic, non flush, standard sensing distance	M8, threaded	3-wire, PNP 24V	XS4P08P●340●																	
		3-wire, PNP 24V-48V	XS4P08P●370●																	
		3-wire, NPN 24V	XS4P08N●340●																	
		3-wire, NPN 24V-48V	XS4P08N●370●																	
		2-wire, AC/DC	XS4P08M●230●●●																	
		M12, threaded	3-wire, PNP 24V	XS4P12P●340●																
	3-wire, PNP 24V-48V		XS4P12P●370●																	
	3-wire, NPN 24V		XS4P12N●340●																	
	3-wire, NPN 24V-48V		XS4P12N●370●																	
	2-wire, AC/DC		XS4P12M●230●●●																	
	M18, threaded	3-wire, PNP 24V	XS4P18P●340●																	
		3-wire, PNP 24V-48V	XS4P18P●370●																	
		3-wire, NPN 24V	XS4P18N●340●																	
		3-wire, NPN 24V-48V	XS4P18N●370●																	
		2-wire, AC/DC	XS4P18M●230●●●																	
	M30, threaded	3-wire, PNP 24V	XS4P30P●340●																	
		3-wire, PNP 24V-48V	XS4P30P●370●																	
		3-wire, NPN 24V	XS4P30N●340●																	
		3-wire, NPN 24V-48V	XS4P30N●370●																	
	2-wire, AC/DC	XS4P30M●230●●●																		

Compatible  
Incompatible

# Modicon X80 modules platform

## Inputs and OsiSense XS inductive proximity sensors (continued)

Proximity sensors				⋮ inputs, BMXDDI				⋮ inputs, BMXDDM			⋮ inputs, BMXAMI		~ inputs, BMXDAI						
Type	Reference			1602	1603	1604T	3202K	6402K	16022	16025	3202K	0810	0800	1602	1603	1604	0805	0814	
<b>General purpose</b>																			
Cylindrical basic flush or non flush, standard sensing distance Plastic or metal	Ø 6.5 plain	3-wire, PNP 24V	XS1/206BLP●●●																
		3-wire, NPN 24V	XS1/206BLN●●●																
	M8, threaded	3-wire, PNP 24V	XS1/208A/BLP●●●																
		3-wire, NPN 24V	XS1/208A/BLN●●●																
	M12, threaded	3-wire, PNP 24V	XS1/212A/BLP●●●																
		3-wire, NPN 24V	XS1/212A/BLN●●●																
	M18, threaded	3-wire, PNP 24V	XS1/218A/BLP●●●																
		3-wire, NPN 24V	XS1/218A/BLN●●●																
	M30, threaded	3-wire, PNP 24V	XS1/230A/BLP●●●																
		3-wire, NPN 24V	XS1/230A/BLN●●●																
	Cylindrical, almost flush, extended sensing distance	M18, threaded	3-wire, PNP 24V	XS1N18P●349●															
			3-wire, NPN 24V	XS1N18N●349●															
M30, threaded		3-wire, PNP 24V	XS1N30P●349●																
		3-wire, NPN 24V	XS1N30N●349●																
Cylindrical, miniature	Ø 4 plain	3-wire, PNP 24V	XS1L04P●31●●																
		3-wire, NPN 24V	XS1L04N●31●●																
	M5, threaded	3-wire, PNP 24V	XS1N05P●31●●																
		3-wire, NPN 24V	XS1N05N●31●●																
	Ø 6.5 plain	3-wire, PNP 24V	XS2L06P●340●																
		3-wire, NPN 24V	XS2L06N●340●																
<b>Application</b>																			
Cylindrical, adjustable sensing distance	M12, threaded	3-wire, PNP 24V	XS612B2P●●●																
		3-wire, NPN 24V	XS612B2N●●●																
	M18, threaded	3-wire, PNP 24V	XS618B2P●●●																
		3-wire, NPN 24V	XS618B2N●●●																
M30, threaded	3-wire, PNP 24V	XS630B2P●●●																	
	3-wire, NPN 24V	XS630B2N●●●																	
Rotation monitoring	M18, threaded	3-wire, PNP 24V-48V	XSAV11/2373																
		2-wire, AC/DC	XSAV11/2801																
	Format E 26x26x13	3-wire, PNP 24V	XS9●11RP●●●●																
Analog output	M12, threaded	2-wire 4...20mA; 3-wire 0...10V	XS●12AB●●●●																
		2-wire 4...20mA; 3-wire 0...10V	XS●18AB●●●●																
	M30, threaded	2-wire 4...20mA; 3-wire 0...10V	XS●30AB●●●●																
		2-wire 4...20mA; 3-wire 0...10V	XS9C2/C4A2A●●●●																
	Block format	2-wire 4...20mA; 3-wire 0...10V	XS9●111A●●●●																
Food and beverage	Cylindrical threaded metal	3-wire, PNP 24V	XS2●●SAP●●●																
		3-wire, PNP 24V	XS908/12/18/30R/S●P●●●																
		3-wire, NPN 24V	XS2●●SAN●●●																
		2-wire, AC/DC	XS2●●SAMA●●●																
	Cylindrical threaded plastic	3-wire, PNP 24V-48V	XS2●●AAP●●●																
		3-wire, NPN 24V	XS2●●AAN●●●																
		2-wire, AC/DC	XS2●●AAMA●●●																
		4-wire, PNP+NPN 24V	XS1M●●KPM40																
Factor 1	Format C, 40 x 117 x 41	4-wire, PNP+NPN 24V	XS9C2/C4A●●●●																
	Cylindrical threaded metal	3-wire, PNP 24V	XS1M18PAS●●																
Packaging	Format 12x26x40	3-wire, PNP 24V	XS7G12P●140																
		3-wire, NPN 24V	XS7G12N●140																
	4-wire, PNP 24V-48V	4-wire, PNP 24V-48V	XS7G12P●440																
		4-wire, NPN 24V-48V	XS7G12N●440																
	2-wire, AC/DC	XS7G12M●230																	
Material handling	Format C 40x40x40	2-wire, DC 24V-48V	XS7T4DA●●●																
		4-wire, PNP 24V-48V	XS7T4PC●●●																
		4-wire, NPN 24V-48V	XS7T4NC●●●																
Welding	Format D 80x80x26	2-wire, DC 24V-48V	XS7D1●●●●																
		3-wire, PNP 24V	XS1M●●PAW●●																
Cylindrical metal	2-wire, DC 24V-48V		XSLC●●●																

Compatible  
Incompatible



---

## Technical appendices

- Standards, certifications, and environmental conditions ..... [page 8/2](#)
- Certifications for automation products and EC regulations ..... [page 8/8](#)

### Standards and certifications

The Modicon X80 I/O platform has been developed to comply with the principal national and international standards concerning electronic equipment for industrial automation systems.

- Requirements specific to programmable controllers: functional characteristics, immunity, resistance, safety, etc.: IEC/EN 61131-2, IEC/EN/UL/CSA 61010-2-201, and UL508
- Requirements specific to power utility automation systems: IEC/EN 61000-6-5, IEC/EN 61850-3
- Merchant navy requirements of the major international organizations: unified in IACS (International Association of Classification Societies)
- Compliance with European Directives for CE marking:
  - Low voltage: 2014/35/EU
  - Electromagnetic compatibility: 2014/30/EU
  - Machinery: 2006/42/EC
  - Ex areas:
    - For USA and Canada: Hazardous location class I, division 2, groups A,B,C, and D
    - For other countries: CE ATEX (2014/34/EU) or IECEx in defined atmosphere Zone 2 (gas) and/or Zone 22 (dust)

Up-to-date information on which certifications have been obtained is available on our website.

The X80 I/O platform is considered as open equipment and is designed for use in industrial environments, in pollution degree 2, overvoltage category II (IEC 60664-1), and in low-voltage installations, where the main power branch is protected on both wires by devices such as fuses or circuit breakers limiting the current to 15A for North America and 16A for the rest of the world.

All Safety modules are certified by TÜV Rheinland. The certificate reviews the following standards:

#### Functional safety specifications

IEC 61508: Functional safety of electrical/electronic/programmable electronic safety-related systems

- IEC 61508-1 - Part 1: General requirements
- IEC 61508-2 - Part 2: Requirements for electrical/electronic/programmable electronic safety-related systems
- IEC 61508-3 - Part 3: Software requirements

IEC 61511: Functional safety - Safety instrumented systems for the process industry sector

- IEC 61511-1 - Part 1: Framework, definitions, system, hardware and software requirements
- IEC 61511-2 - Part 2: Guidelines for the application of IEC 61511-1
- IEC 61511-3 - Part 3: Guidance for the determination of the required safety integrity levels

#### Safety machinery specifications

- IEC 62061: Safety of machinery - Functional safety of safety-related electrical, electronic and programmable electronic control systems
- ISO 13849-1: Safety of machinery - Safety-related parts of control systems - Part 1: General principles for design
- ISO 13849-2: 2012 Safety-related parts of control systems - Part 2: Validation

#### Fire & Gas specifications

- EN54.2: 1997 + Amd1 2007 fire detection + fire alarms systems – Part 2: Control and indicating equipment
- EN 50156-1: 2015 Electrical equipment for furnaces and ancillary equipment - Part 1: Requirements for application design and installation
- EN 50130-4: 2011 Immunity requirements components of fire, intruder, holdup, CCTV, access control and social alarms systems
- EN 298: 2012 Automatic burner control systems for burners and appliances burning gaseous or liquid fuels
- NFPA 85: 2015 Boiler and Combustion Systems Hazards Code
- NFPA 86: 2015 Standard for Ovens and Furnaces
- NFPA 72: 2016 National Fire Alarm and Signaling Code

Characteristics							
Service conditions and recommendations relating to the environment							
			Modicon X80 I/O platform	Modicon M580 Safety platform	Modicon X80 harsh I/O platform		
Temperature	Operation	°C/°F	0...+60/32...140	-25...+60/-13...+140	-25...+70/-13...+158		
	Storage	°C/°F	-40...+85/-40...+185	-40...+85/-40...+185	-40...+85/-40...+185		
Relative humidity (without condensation)	Cyclical humidity	%	+5 ... +95 up to 55 °C/131 °F	+5...+95 up to 55 °C/131 °F	+5 ... +95 up to 55 °C/131 °F		
	Continuous humidity	%	+5 ... +93 up to 55 °C/131 °F	+5...+93 up to 60 °C/140 °F	+5 ... +93 up to 60 °C/140 °F		
Altitude	Operation	m/ft	0 ... 2,000/0... 6,562 (full specification: temperature and isolation) 2,000...5,000/6,562...16,404 (temperature derating: approx. 1 °C/400 m (33.8 °F/1,312 ft), isolation 150 V/1,000 m/3,281 ft) For accurate temperature derating calculation, refer to IEC 61131-2 Ed4.0 Annex A				
			Modicon X80 I/O power supply modules				
Supply voltage			BMXCPS2010	BMXCPS3020 BMXCPS3020H	BMXCPS3540T	BMXCPS2000	BMXCPS3500 BMXCPS3500H BMXCPS3522S BMXCPS4002 BMXCPS4002S BMXCPS4002H BMXCPS4022S
	Nominal voltage	V	24 ---	24...48 ---	125 ---	100...240 ~	100...240 ~
	Limit voltages	V	18...31.2 ---	18...62.4 ---	100...150 ---	85...264 ~	85...264 ~
	Nominal frequencies	Hz	—	—	—	50/60	50/60
	Limit frequencies	Hz	—	—	—	47/63	47/63

### Protective treatment of the Modicon X80 I/O platform

The Modicon X80 I/O platform meets the requirements of "TC" treatment (treatment for all climates). For installations in industrial production workshops or environments corresponding to "TH" treatment (treatment for hot and humid environments), Modicon X80 I/O must be housed in enclosures with minimum IP54 protection.

The Modicon X80 I/O platform offers **protection to IP20 level** and **protection against access to terminals** (enclosed equipment) (1). It can therefore be installed without an enclosure in reserved-access areas that do not exceed **pollution level 2** (control room with no dust-producing machinery or activity). Pollution level 2 does not take account of more severe environmental conditions: air pollution by dust, smoke, corrosive or radioactive particles, vapors or salts, molds, insects, etc.

(1) In cases where a slot is not occupied by a module, a **BMXXEM010** protective cover must be installed.

(C€): Tests required by European directives (C€) and based on IEC/EN 61131-2 standards.



Environment tests		
Name of test	Standards	Levels
<b>Immunity to LF interference (CE) (1)</b>		
Voltage and frequency variations	IEC/EN 61131-2; IEC/EN 61000-6-2; IEC 61000-4-11 IACS E10; IEC 61000-4-11	0.85...1.10 Un - 0.94...1.04 Fn; 4 steps t = 30 min 0.80 Un...0.90 Fn; 1.20 Un...1.10 Fn; t = 1.5 s/5 s
Direct voltage variations	IEC/EN 61131-2; IEC 61000-4-29; IACS E10 (PLC not connected to charging battery)	0.85...1.2 Un + ripple: 5% peak; 2 steps t = 30 min
Third harmonic	IEC/EN 61131-2	H3 (10% Un), 0°/180°; 2 steps t = 5 min
Immunity to conducted low frequency (only IACS)	IACS E10	For ~ : ■ H2...H15 (10% Un), H15...H100 (10%...1% Un), H100...H200 (1% Un) For --- : ■ H2...H200 (10% Un)
Voltage interruptions	IEC/EN 61131-2; IEC/EN 61000-6-2; IEC 61000-4-11; IEC 61000-4-29; IACS E10 For functional safety (DS criteria): IEC 61000-6-7; IEC 61326-3-1  IEC/EN 61131-2; IEC/EN 61000-6-2; IEC 61000-4-11	Power supply immunity: ■ 1 ms for --- PS1/10 ms for ~ PS2 (20 ms DS criteria), 85% Un ■ Check operating mode for longer interruptions ■ up to 5s, 85% Un ■ for IACS, 3 times 30 s in 5 min, 85% Un  For ~ PS2: ■ 20% Un, t0: ½ period ■ 40% Un, cycle 10/12 ■ 70% Un, cycle: 25/30 ■ 0% Un, cycle 250/300
Voltage shut-down and start-up	IEC/EN 61131-2	■ Un...0...Un; t = Un/60 s ■ Umin...0...Umin; t = Umin/5 s ■ Umin...0.9 Udl...Umin; t = Umin/60 s
Magnetic field	IEC/EN 61131-2; IEC 61000-4-8 (for MV power stations: IEC 61000-6-5; IEC 61850-3) For functional safety (DS criteria): IEC 61000-6-7; IEC 61326-3-1 IEC 61000-4-10	Power frequency: 50/60 Hz, 100 A/m continuous ...1000 A/m; t = 3 s; 3 axes  Oscillatory: 100 kHz...1 MHz, 100 A/m; t = 9 s; 3 axes
Conducted common mode disturbances range 0 Hz ...150 kHz	IEC 61000-4-16 (for MV power stations: IEC 61000-6-5; IEC 61850-3) For functional safety (DS criteria): IEC 61000-6-7; IEC 61326-3-1	For remote systems: ■ 50/60 Hz and ---, 300 V, t = 1 s ■ 50/60 Hz and ---, 30 V, t = 1 min ■ 5 Hz...150 kHz, sweep 3 V...30 V ■ For AC: 10 V ■ For DC: 10 V cont. or 100 V, t = 1 s

Where:

- PS1 applies to PLC supplied by battery, PS2 applies to PLC energized from ~ or --- supplies
- Un: nominal voltage, Fn: nominal frequency, Udl: detection level when powered

(1) Devices must be installed, wired, and maintained in accordance with the instructions provided in the manual "Grounding and Electromagnetic Compatibility of PLC Systems".

(2) These tests are performed without an enclosure, with devices fixed on a metal grid and wired as per the recommendations in the manual "Grounding and Electromagnetic Compatibility of PLC systems".

(CE): Tests required by European CE directives and based on IEC/EN 61131-2.

Environment tests (continued)		
Name of test	Standards	Levels
<b>Immunity to HF interference (CE) (1)</b>		
Electrostatic discharges	IEC/EN 61131-2; IEC/EN 61000-6-2; IEC 61000-4-2; IACS E10 For functional safety (DS criteria): IEC 61000-6-7; IEC 61326-3-1	6 kV contact; 8 kV air; 6 kV indirect contact
Radiated radio frequency electromagnetic field	IEC/EN 61131-2; IEC/EN 61000-6-2; IEC 61000-4-3; IACS E10 For functional safety (DS criteria): IEC 61000-6-7; IEC 61326-3-1	80MHz...1GHz: 10/15 V/m (20 V/m DS criteria); 3 V/m, 1.4 GHz...2 GHz: 3V/m (10 V/m DS criteria) 2 GHz...6 GHz: 3V/m Sinus amplitude modulated 80%, 1 kHz + internal clock frequencies
Electrical fast transient bursts	IEC/EN 61131-2; IEC/EN 61000-6-2; IEC 61000-4-4; IACS E10 For functional safety (DS criteria): IEC 61000-6-7; IEC 61326-3-1	For ~ or --- main supplies: ■ 2 kV in common mode/2 kV in wire mode (4 kV DS criteria with external protection) For ~ or --- auxiliary supplies, ~ unshielded I/O: ■ 2 kV in common mode For analog, --- unshielded I/O, communication and shielded lines: ■ 1 kV in common mode (3 kV DS criteria)
Surge	IEC/EN 61131-2; IEC/EN 61000-6-2; IEC 61000-4-5; IACS E10 For functional safety (DS criteria): IEC 61000-6-7; IEC 61326-3-1	For ~/--- main and auxiliary supplies, ~ unshielded I/O: ■ 2 kV in common mode/1 kV in differential mode (4 kV DS criteria with external protection) For analog, --- unshielded I/O: ■ 2 kV in common mode/2 kV in differential mode For communication and shielded lines: ■ 1 kV in common mode (3 kV DS criteria)
Conducted disturbances induced by radiated electromagnetic fields	IEC/EN 61131-2; IEC/EN 61000-6-2; IEC 61000-4-6; IACS E10 For functional safety (DS criteria): IEC 61000-6-7; IEC 61326-3-1	10 V; 0.15 MHz...80 MHz (20 V DS criteria) Sinus amplitude 80%, 1 kHz + spot frequencies
Damped oscillatory wave	IEC/EN 61131-2; IEC 61000-4-18; IACS E10	For ~/--- main supplies and ~ auxiliary supplies, ~ unshielded I/O: ■ 2.5 kV in common mode/1 kV in differential mode For --- auxiliary supplies, analog, --- unshielded I/O: ■ 1 kV in common mode/0.5 kV in differential mode For communication and shielded lines: ■ 0.5 kV in common mode

(1) Devices must be installed, wired, and maintained in accordance with the instructions provided in the manual "Grounding and Electromagnetic Compatibility of PLC Systems".

(2) These tests are performed without an enclosure, with devices fixed on a metal grid and wired as per the recommendations in the manual "Grounding and Electromagnetic Compatibility of PLC systems".

(CE): Tests required by European CE directives and based on IEC/EN 61131-2.

Environment tests (continued)		
Name of test	Standards	Levels
<b>Electromagnetic emissions (CE) (1)</b>		
Conducted emissions	IEC/EN 61131-2; IEC/EN 61000-6-4; CISPR 11 & 22, Class A, Group 1 (FCC part 15 compliance)	150 kHz ... 500 kHz: quasi-peak 79 dB (µV/m); average 66 dB (µV/m) 500 kHz ... 30 MHz: quasi-peak 73 dB (µV/m); average 60 dB (µV/m)
	IACS E10	■ ~ power (general power distribution zone): 10 kHz ... 150 kHz: quasi-peak 120...69 dB (µV/m); 150 kHz ... 0.5 MHz: quasi-peak 79 dB (µV/m) 0.5 MHz ... 30 MHz: quasi-peak 73 dB (µV/m) ■ ~ power (bridge and deck zone for evaluation): 10 kHz ... 150 kHz: quasi-peak 96...50 dB (µV/m) 150 kHz ... 0.35 MHz: quasi-peak 60...50 dB (µV/m) 0.35 MHz ... 30 MHz: quasi-peak 50 dB (µV/m)
Radiated emissions	IEC/EN 61131-2; IEC/EN 61000-6-4; CISPR 11 & 22, Class A, Group 1 (FCC part 15 compliance)	30 MHz ... 230 MHz: quasi-peak 40 dB (µV/m) (at 10 m/33 ft) 230 MHz ... 1 GHz: quasi-peak 47 dB (µV/m) (at 10 m/33 ft) 1 GHz ... 3 GHz: quasi-peak 76 dB (µV/m) (at 3 m/9.84 ft) 3 GHz ... 6 GHz: quasi-peak 80 dB (µV/m) (at 3 m/9.84 ft)
	IACS E10	■ For general power distribution zone 0.15 MHz ... 30 Mhz: quasi-peak 80...50 dB (µV/m) (at 3 m/9.84 ft) 30 MHz-100 MHz: quasi-peak 60...54 dB (µV/m) (at 3 m/9.84 ft) 100 MHz - 2 GHz: quasi-peak 54 dB (µV/m) (at 3 m/9.84 ft) 156 ... 165 MHz: quasi-peak 24 dB (µV/m) (at 3 m/9.84 ft)
Name of test	Standards	Levels
<b>Immunity to climatic variations (1) (power on)</b>		
Dry heat	IEC 60068-2-2 (Bb & Bd)	60 °C/140 °F, t = 16 hrs [for ruggedized range: 70 °C/158 °F, t = 16 hrs] (2)
	IACS E10	60 °C/140 °F, t = 16 hrs + 70 °C/158 °F, t = 2 hrs [for ruggedized range: 70 °C/158 °F, t = 18 hrs] (2)
Cold	IEC 60068-2-1 (Ab & Ad) IACS E10	0 °C...-25 °C/32 °F...-13 °F, t = 16 hrs + power on at 0 °C/ 32 °F [for ruggedized range: power on at -25 °C/-13 °F] (2)
Damp heat, steady state (continuous humidity)	IEC 60068-2-78 (Cab); IACS E10	55 °C/131 °F, 93% relative humidity, t = 96 hrs [for ruggedized range: 60 °C/140 °F] (2)
Damp heat, cyclic (cyclical humidity)	IEC 60068-2-30 (Db); IACS E10	55 °C...25 °C/131 °F...77 °F, 93...95% relative humidity, 2 cycles t = 12 hrs + 12 hrs
Change of temperature	IEC 60068-2-14 (Nb)	0 °C ... 60 °C/32 °F...140 °F, 5 cycles t = 6 hrs + 6 hrs [for ruggedized range: -25 °C...70 °C/-13 °F...158 °F] (2)
Name of test	Standards	Levels
<b>Withstand to climatic variations (1) (power off)</b>		
Dry heat	IEC/EN 61131-2; IEC 60068-2-2 (Bb & Bd) IEC/EN 60945	85 °C/185 °F, t = 96 hrs
Cold	IEC/EN 61131-2; IEC 60068-2-1 (Ab & Ad); IACS E10	-40 °C/-40 °F, t = 96 hrs
Damp heat, cyclic (cyclical humidity)	IEC/EN 61131-2; IEC 60068-2-30 (Db)	55 °C...25 °C/77 °F...131 °F, 93...95% relative humidity, 2 cycles t = 12 hrs + 12 hrs
Change of temperature (thermal shocks)	IEC/EN 61131-2; IEC 60068-2-14 (Na)	-40 °C...85 °C/-40 °F...185 °F, 5 cycles t = 3 hrs + 3 hrs

(1) Devices must be installed, wired, and maintained in accordance with the instructions provided in the manual "Grounding and Electromagnetic Compatibility of PLC Systems".

(2) Refer also to the section "Treatment for severe environments".

(CE): Tests required by European CE directives and based on IEC/EN 61131-2 standards.

Environment tests (continued)		
Name of test	Standards	Levels
<b>Immunity to mechanical constraints (1) (power on)</b>		
Sinusoidal vibrations	IEC/EN 61131-2; IEC 60068-2-6 (Fc)	Basic IEC/EN 61131-2: 5 Hz ... 150 Hz, $\pm 3.5$ mm/0.14 in. amplitude (5 Hz ... 8.4 Hz), 1 g (8.4 Hz ... 150 Hz) Specific profile: 5 Hz ... 150 Hz, $\pm 10.4$ mm/0.41 in. amplitude (5 Hz ... 8.4 Hz), 3 g (8.4 Hz ... 150 Hz) For basic and specific: endurance: 10 sweep cycles for each axis
	IEC 60870-2-2 ; IEC 60068-2-6 (Class Cm)	2 Hz ... 500 Hz, 7 mm/0.28 in. amplitude (2 Hz ... 9 Hz), 2 g (9 Hz ... 200 Hz), 1.5 g (200 Hz ... 500 Hz) endurance: 10 sweep cycles for each axis
	IACS E10	3 Hz ... 100 Hz, 1 mm/0.04 in. amplitude (3 Hz ... 13.2 Hz), 0.7 g (13.2 Hz ... 100 Hz) Endurance at each resonance frequency: 90 min for each axis, amplification coefficient < 10
	IEC 60068-2-6	Seismic analysis: 3 Hz ... 35 Hz, 22.5 mm/0.89 in. amplitude (3 Hz ... 8.1 Hz), 6 g (8.1 Hz ... 35 Hz)
Shock	IEC/EN 61131-2; IEC 60068-2-27 (Ea)	30 g, 11 ms; 3 shocks/direction/axis (2) For M580 Safety: 15 g, 11 ms; 3 shocks/direction/axis 25 g, 6 ms; 100 bumps/direction/axis (bumps) (3)
Free fall during operation	IEC/EN 61131-2; IEC 60068-2-32 (Ed Method 1)	1 m/3.28 ft, 2 falls
<b>Name of test</b>		
<b>Standards</b>		
<b>Levels</b>		
<b>Withstand to mechanical constraints (power off)</b>		
Random free fall with packaging	IEC/EN 61131-2; IEC 60068-2-32 (Method 1)	1 m/3.28 ft, 5 falls
Flat free fall	IEC/EN 61131-2; IEC 60068-2-32 (Ed Method 1)	10 cm/0.33 ft, 2 falls
Controlled free fall	IEC/EN 61131-2; IEC 60068-2-31 (Ec)	30° or 10 cm/0.33 ft, 2 falls
Plugging/Unplugging	IEC/EN 61131-2	For modules and connectors: Operations: 50 for permanent connections, 500 for non-permanent connections
<b>Name of test</b>		
<b>Standards</b>		
<b>Levels</b>		
<b>Equipment and personnel safety (1) (CE)</b>		
Dielectric strength and insulation resistance	IEC/EN 61131-2; IEC 61010-2-201; UL; CSA	Dielectric: 2 Un + 1000 V; t = 1 min Insulation: Un $\leq$ 50 V: 10 M $\Omega$ , 50 V $\leq$ Un $\leq$ 250 V : 100 M $\Omega$
Ground continuity	IEC/EN 61131-2; IEC 61010-2-201; UL; CSA	30A, R $\leq$ 0,1 $\Omega$ ; t = 2 min
Leakage current	IEC/EN 61131-2; IEC 61010-2-201; UL; CSA	$\leq$ 0.5 mA in normal condition $\leq$ 3.5 mA in single fault condition
Protection offered by enclosures	IEC/EN 61131-2; IEC61010-2-201;	IP20 and protection against standardized pins
Impact withstand	IEC/EN 61131-2; IEC 61010-2-201; UL; CSA	Sphere of 500 g, fall from 1.3 m/4.27 ft (energy 6.8 J minimum)
Overload	IEC/EN 61131-2; IEC 61010-2-201; UL; CSA	50 cycles, Un, 1.5 In; t = 1 s ON + 9 s OFF
Endurance	IEC/EN 61131-2; IEC 61010-2-201; UL; CSA	In, Un; 6,000 cycles: t = 1 s ON + 9 s OFF
Temperature rise	IEC/EN 61131-2; UL; CSA; ATEX; IECEx	Ambient temperature 60 °C/140 °F [for ruggedized range: 70 °C/158 °F] (4)
<b>Name of test</b>		
<b>Standards</b>		
<b>Levels</b>		
<b>Specific environment (4)</b>		
Corrosion areas - gas, salt, dust	ISA S71.4	Flowing mixed gas; class Gx, 25 °C/77 °F, 75% relative humidity, t = 14 days
	IEC/EN 60721-3-3 IEC60068-2-60	Flowing mixed gas; class 3C3, 25 °C/77 °F, 75% relative humidity, t = 14 days
	IEC/EN 60721-3-3 IEC60068-2-60	Flowing mixed gas; class 3C4, 25 °C/77 °F, 75% relative humidity, t = 7 days
	IEC60068-2-52	Salt spray: test Kb, severity 2
	IEC/EN 60721-3-3 IEC60068-2-68	Dust and sand, Arizona dust, class 3S4, 20 cycles
	IEC/EN 60721-3-3 IEC60068-2-10	Mold growth, fungal spore, class 3B2, t=28 days

(1) Devices must be installed, wired, and maintained in accordance with the instructions provided in the manual "Grounding and Electromagnetic Compatibility of PLC Systems".

(2) When using fast actuators (response time  $\leq$  5 ms) driven by relay outputs: 15 g, 11 ms; 3 shocks/direction/axis.

(3) When using fast actuators (response time  $\leq$  15 ms) driven by relay outputs: 15 g, 6 ms; 100 bumps/direction/axis.

(4) Refer also to the section "Treatment for severe environments".

(CE): Tests required by European CE directives and based on IEC/EN 61131-2 standards.

# Technical appendices

## Automation product certifications

### EC regulations

Some countries require certain electrical components to undergo certification by law. This certification takes the form of a certificate of conformity to the relevant standards and is issued by the official body in question. Where applicable, certified devices must be labeled accordingly. Use of electrical equipment on board merchant vessels generally implies that it has gained prior approval (i.e. certification) by certain shipping classification societies.

Abbreviation	Certification body	Country
CSA	Canadian Standards Association	Canada
RCM	Australian Communications and Media Authority	Australia, New Zealand
EAC	Eurasian conformity	Russia and customs union
UL	Underwriters Laboratories	USA









Abbreviation	Classification authority	Country
IACS	International Association of Classification Societies	International
ABS	American Bureau of Shipping	USA
BV	Bureau Veritas	France
DNV	Det Norske Veritas	Norway
GL	Germanischer Lloyd	Germany
LR	Lloyd's Register	UK
RINA	Registro Italiano Navale	Italy
RMRS	Russian Maritime Register of Shipping	Russia
RRR	Russian River Register	Russia
CCS	China Classification Society	China
KRS	Korean Register of Shipping	Korea
Class NK	Nippon Kaiji Kyokai	Japan

**Note:** Due to the merger between DNV and GL certification, DNV/GL will be renewed as a single certificate from 2016.

The following tables provide an overview of the situation as of December 2018, in terms of which certifications (listed next to their respective bodies) have been granted or are pending for our automation products.

Up-to-date information on which certifications have been obtained by products bearing the Schneider Electric brand can be viewed on our website: [www.schneider-electric.com](http://www.schneider-electric.com)

### Product certifications

Certified	Certifications						
					Hazardous locations (1) Class I, div 2	  	
Certification pending	UL	CSA	RCM	EAC		(6)	TÜV Rheinland
	USA	Canada	Australia	Russia	USA, Canada		
Modicon OTB							
Modicon STB					CSA (8)	Zone 2 (2)(5)	
Modicon Telefast ABE 7							
ConneXium					(2)		
Magelis iPC/GTW		(3)		(2)	(3)	Zone 2/22 (2)	
Magelis XBT GT		(3)		(2)	(2) (3)	Zone 2/22 (2)(5)	
Magelis XBT GK		(3)			(3)		
Magelis XBT N/R/RT					CSA	Zone 2/22 (2)(5)	
Magelis HMI GTO		(3)		(2)	(3)	Zone 2/22 (2)	
Magelis HMI STO/STU		(3)		(2)	(2)(3)	Zone 2/22 (2)	
Modicon M340					CSA (8)	Zone 2/22 (2)	
Modicon M580					CSA (8)	Zone 2/22 (2)	
Modicon M580 Safety					CSA (8)	Zone 2/22 (2)	SIL 3, Cat.4, PLe
Modicon X80 I/O					CSA (8)	Zone 2/22 (2)	
Modicon Momentum					CSA (8)		
Modicon Premium				(2)	CSA		
Modicon Quantum				(2)	CSA (8)	Zone 2/22 (2)	
Modicon Quantum Safety				(2)	CSA	Zone 2/22 (2)	SIL 2, SIL 3 (7)
Preventa XPSMF							SIL 3 (7)
Modicon TSX Micro					CSA		
Phaseo	(3)						
Twido	(4)	(4)			CSA/UL (4)		

(1) Hazardous locations: According to ANSI/ISA 12.12.01 and/or CSA 22.2 No. 213, and/or FM 3611, certified products are only approved for use in hazardous locations categorized as Class I, division 2, groups A, B, C, and D, or in non-classified locations.

(2) Depends on product; please visit our website: [www.schneider-electric.com](http://www.schneider-electric.com).

(3) North American certification cULus (Canada and USA).

(4) Except for AS-Interface module TWD NOI 10M3, CE only.

(5) For zones not covered by this specification, Schneider Electric offers a solution as part of the TPP (Technology Partner Program). Please contact our Customer Care Center.

(6) Certified by INERIS. Refer to the instructions supplied with each ATEX and/or IECEx certified product.

(7) According to IEC 61508. Certified by TÜV Rheinland for integration into a safety function of up to SIL 2 or SIL 3.











(8) CSA Hazardous Location according to ANSI/ISA 12.12.01, CSA 22.2 No. 213, and FM 3611.

# Technical appendices

## Automation product certifications

### EC regulations

#### Merchant navy certifications

Certified Certification pending	Shipping classification societies										
											
	USA	France	Norway	Germany	Korea	Great Britain	Italy	Russia	Russia	China	Japan
Modicon OTB											
Modicon STB											
Modicon Telefast ABE 7											
ConneXium											
Magelis iPC/GTW											
Magelis XBT GT											
Magelis XBT GK											
Magelis XBT N/R											
Magelis XBT RT											
Magelis HMI GTO											
Magelis HMI STO/STU											
Modicon M340											
Modicon M580											
Modicon M580 Safety											
Modicon X80 I/O											
Modicon Momentum											
Modicon Premium											
Modicon Quantum											
Modicon TSX Micro											
Phaseo											
Twido											

#### EC regulations

##### European Directives

The open nature of the European markets assumes harmonization between the regulations set by the member states of the European Union. European Directives are texts intended to remove restrictions on free circulation of goods and which must be applied within all European Union states.

Member states are obligated to incorporate each Directive into their national legislation, and to simultaneously withdraw any regulations that contradict it.

Directives - and particularly those of a technical nature with which we are concerned - merely set out the objectives to be fulfilled (referred to as "essential requirements"). Manufacturers are responsible for taking the necessary measures to establish that their products conform to the requirements of each Directive applicable to their equipment.

As a general rule, manufacturers certify compliance with the essential requirements of the Directive(s) that apply to their products by applying a CE mark. The CE mark is affixed to our products where applicable.

##### Significance of the CE mark

The CE mark on a product indicates the manufacturer's certification that the product conforms to the relevant European Directives; this is a prerequisite for placing a product that is subject to the requirements of one or more Directives on the market and allowing its free circulation within European Union countries. The CE mark is intended for use by those responsible for regulating national markets.

Where electrical equipment is concerned, conformity to standards indicates that the product is fit for use. Only a warranty by a well-known manufacturer can provide reassurance of a high level of quality.

As far as our products are concerned, one or more Directives are likely to apply in each case; in particular:

- The Low Voltage Directive (2014/35/EU)
- The Electromagnetic Compatibility Directive (2014/30/EU)
- The ATEX CE Directive (2014/34/EU)
- The Machinery Directive (2006/42/EU)

##### Hazardous substances

These products are compatible with:

- The WEEE Directive (2012/19/EU)
- The RoHS Directive (2011/65/EU)
- The China RoHS Directive (Standard GB/T 26572-2011)
- REACH regulations (EC 1907/2006)

*Note: Documentation on sustainable development is available on our website [www.schneider-electric.com](http://www.schneider-electric.com) (product environmental profiles and instructions for use, RoHS and REACH directives).*

##### End of life (WEEE)

End of life products containing electronic cards must be dealt with by specific treatment processes.

When products containing backup batteries are unusable or at end of life they must be collected and treated separately. Batteries do not contain a percentage by weight of heavy metals above the limit specified by European Directive 2013/56/EU.



---

**A dedicated services offer for your installed base**

- Maintenance and support services ..... [page 9/2](#)
- Consultancy services ..... [page 9/3](#)
- Modernization solutions ..... [page 9/3](#)
- Customization services ..... [page 9/3](#)

**Index**

- Product reference index ..... [page 9/4](#)



# A dedicated services offer for your installed base



Schneider Electric, with its experts, products and dedicated tools, provides services such as system design, consultancy, maintenance contracts, modernization of facilities or delivering projects.

The Schneider Electric services offer is structured around several key areas:

- Maintenance and support services:
  - A set of services to help maintain reliability and availability of automated control systems. These services may be the subject of a bespoke maintenance contract to meet your requirements more closely.
- Consultancy services:
  - Diagnostics of the installed base
- Modernization solutions:
  - Migration solutions including consultancy, expertise, tools and technical support to help ensure a smooth transition to newer technology while keeping the wiring and the encoding in most cases.

Customization services are also available to accommodate specific requirements. For more information, please consult the specific pages on our website [www.schneider-electric.com/automationservices](http://www.schneider-electric.com/automationservices)

## Maintenance and support services

### Spare parts, exchanges and repairs

#### *Everything you need to get equipment working again as quickly as possible*

Solutions to respond very quickly to requests for spare parts, exchanges and repairs to your installed automation equipment (automation platforms, Human Machine Interfaces, drives, distributed I/O):

- Spare parts management:
  - Identification of critical parts
  - Stock of spare parts: a Schneider Electric owned stock of spare parts, on your site or in one of our warehouses, with immediate availability on site or a contractually agreed delivery time if stored off site
  - Testing of spare parts stored on site
  - Automatic stock filling
- Repairs:
  - Broken down products are repaired in a network of worldwide repair centres. For each repaired product, our experts provide a detailed report.
- On-site repair:
  - Our experts' knowledge and expertise
  - Monitoring of specific repair procedures
  - Availability of our teams to respond 24/7
- Exchanges:
  - With standard replacements, receive a new or reconditioned product before the broken down product has even been sent back
  - Fast exchanges offer the option to receive the replacement product within 24 hours (in Europe)

### Preventive maintenance

#### *Improving and guaranteeing the long-term reliability and performance of your installations*

Schneider Electric's preventive maintenance expert assesses your site, the equipment to be managed and sets up a maintenance program to accommodate specific requirements. A list is provided of the tasks to be performed and their frequency, including site-specific tasks, describing how preventive maintenance is to be managed.

### Extended warranty

#### *An additional manufacturer warranty covering replacement or repair of the equipment*

The extended warranty offers the option to take out a 3-year warranty. The warranty period can vary according to the geographical area, consult your Customer Care Centre.

### Online support

#### *Access to dedicated experts*

Priority access to experts who can answer technical questions promptly concerning equipment and software both on sale and no longer commercially available.

### Software subscription

#### *Access to software upgrades and new features*

By subscribing to software updates, users are able to:

- Purchase licences
- Receive updates, upgrades, software migrations and transitions
- Download software from Schneider Electric's software library

## Consultancy services

### M2C (Maintenance and Modernization Consultancy)

*Professional tools and methods, proven experience of managing obsolescence and updating installed bases, to reduce downtimes and improve performance*

With our maintenance and modernization consultancy offer, Schneider Electric will help you check the state of your installed base by:

- Defining the scope and depth of the analysis in collaboration with you
- Collecting the technical data without shutting down production
- Analyzing and identifying avenues for improvement
- Producing a recommendation plan

Customer benefits:

- Learning about the components that make up the installed base and how up-to-date they are
- Better downtime anticipation
- Expert advice designed to improve performance

## Modernization solutions

### Migration to EcoStruxure

*Proven expertise, tools and methods to give you a clear vision of the improvement opportunities and guide you toward a successful modernization project*



To find out more about EcoStruxure architectures, please visit our website [www.schneider-electric.com/EcoStruxure](http://www.schneider-electric.com/EcoStruxure)

Schneider Electric offers gradual solutions of modernization through a set of products, tools and services that allow you to upgrade your installations with our last technologies. Our solutions offer you the choice to plan your modernization:

- Partial modernization: replacement of an old set of components with a new one
- Step by Step modernization: gradual incorporation of new Solutions or Offers in the system
- Complete modernization: total renovation of the system

The table below lists our various migration offers:

Wide range of migration offers		Moving to M580/M340/X80 platform						
Solution		Solution Type			Tools	Solution Services		
		Change the CPU and retain the I/O racks & wiring	Change the CPU & the I/O racks & retain I/O field wiring with wiring system	Change the CPU & the I/O racks & the I/O wiring	SoftWare application conversion tool	Modernization / migration service	Manage your project	Execute your project
Platform	Premium	☑	☑	☑	☑	☑	☑	☑
	TSX47 to TSX107		☑	☑	☑	☑	☑	☑
	Quantum	☑	☑	☑	☑	☑	☑	☑
	Modicon 984 & 800 Series I/O	☑	☑	☑	☑	☑	☑	☑
	Modicon Compact		☑	☑	☑	☑	☑	☑
	Symax	☑	(1)	☑	☑	☑	☑	☑
	April series 1000		(2)	☑	☑	☑	☑	☑
	April SMC			☑	☑	☑	☑	☑
	Merlin Gerin PB			☑		☑	☑	☑
	AEG		(1)	☑		☑	☑	☑
	Rockwell SLC500		☑	☑	☑	☑	☑	☑
	Rockwell PLC 5	☑	☑	☑	☑	☑	☑	☑

☑ Service available

(1) Consult Schneider services - project specific solution is possible  
 (2) For April series 1000 (April 5000-7000 also the April 2000-3000)  
 Consult Schneider services - project specific solution is possible

## Customization services

Schneider Electric is able to meet your specific requirements and provide you with adapted products:

- Protective coating for Human Machine Interfaces, automation platforms and distributed I/O modules for use in harsh environments
- Customized cable lengths to match your specific needs
- Customized front panels for Human Machine Interfaces
- The preparation before use of The Multi-Use Flying Lead I/O adapter can be made in the factory on request.

*Note: To check availability of services required, please contact our Customer Care Centre.*

<b>A</b>		<b>BMXCPS3500H</b>	6/3	<b>BMXERT1604H</b>	6/11	<b>BMXFTB2800</b>	3/23	<b>BMXXBP1200</b>	2/4
<b>ABE7CPA02</b>	3/23	<b>BMXCPS3522</b>	2/11		3/33		3/33	<b>BMXXBP1200H</b>	6/4
	6/8	<b>BMXCPS3522H</b>	6/3	<b>BMXERT1604T</b>	3/33		3/35	<b>BMXXEM010</b>	2/5
<b>ABE7CPA03</b>	3/23	<b>BMXCPS3522S</b>	4/5	<b>BMXETM0200H</b>	3/41		3/37		6/4
	6/8	<b>BMXCPS3540T</b>	2/11		6/11		6/8	<b>BMXXSP0400</b>	2/5
<b>ABE7CPA21</b>	3/23	<b>BMXCPS4002</b>	2/11	<b>BMXFCA150</b>	3/23	<b>BMXFTB2820</b>	3/23		6/4
	6/8	<b>BMXCPS4002H</b>	6/3		6/8		3/33	<b>BMXXSP0600</b>	2/5
<b>ABE7CPA31</b>	3/23	<b>BMXCPS4002S</b>	4/5	<b>BMXFCA152</b>	3/23		3/35		6/4
<b>ABE7CPA31E</b>	3/23	<b>BMXCPS4022</b>	2/11		6/8		3/37	<b>BMXXSP0800</b>	2/5
<b>ABE7CPA410</b>	3/23	<b>BMXCPS4022H</b>	6/3	<b>BMXFCA300</b>	3/23		6/8		6/4
	6/8	<b>BMXCPS4022S</b>	4/5		6/8		6/11	<b>BMXXSP1200</b>	2/5
<b>ABE7CPA412</b>	3/23	<b>BMXCRA31210C</b>	6/10	<b>BMXFCA302</b>	3/23	<b>BMXFTB4000</b>	3/13		6/4
	6/8	<b>BMXDIAI0805</b>	3/12		6/8	<b>BMXFTB4000H</b>	6/6	<b>BMXXTSCPS10</b>	2/11
<b>ASITERV2</b>	5/25	<b>BMXDIAI0814</b>	3/12	<b>BMXFCA500</b>	3/23	<b>BMXFTB4020</b>	3/13		4/5
		<b>BMXDIAI1602</b>	3/12		6/8	<b>BMXFTB4020H</b>	6/6		6/3
		<b>BMXDIAI1602H</b>	6/6	<b>BMXFCA502</b>	3/23	<b>BMXFTW301</b>	3/13	<b>BMXXTSCPS20</b>	2/11
		<b>BMXDIAI1603</b>	3/12		6/8		6/7		4/5
		<b>BMXDIAI1603H</b>	6/6	<b>BMXFCC051</b>	3/13	<b>BMXFTW301S</b>	3/23		6/3
		<b>BMXDIAI1604</b>	3/12	<b>BMXFCC053</b>	3/13		6/8	<b>BMXXTSHSC20</b>	3/31
		<b>BMXDIAI1604H</b>	6/6	<b>BMXFCC101</b>	3/13		6/7		6/11
		<b>BMXDIAI1604H</b>	6/6	<b>BMXFCC103</b>	3/13	<b>BMXFTW305</b>	6/7		
		<b>BMXDIAI1614</b>	3/12	<b>BMXFCC201</b>	3/13	<b>BMXFTW308S</b>	3/23		
		<b>BMXDIAI1614H</b>	6/6	<b>BMXFCC203</b>	3/13		6/8	<b>P</b>	
		<b>BMXDIAI1615</b>	3/12	<b>BMXFCC301</b>	3/13	<b>BMXFTW501</b>	3/13	<b>PMEGSP0100</b>	5/37
		<b>BMXDIAI1615H</b>	6/6	<b>BMXFCC303</b>	3/13		6/7	<b>PMEPXM0100</b>	5/31
		<b>BMXDIAI1615H</b>	6/6	<b>BMXFCC501</b>	3/13	<b>BMXFTW501S</b>	3/23	<b>PMEPXM0100H</b>	6/9
		<b>BMXDIAI1615H</b>	6/6	<b>BMXFCC503</b>	3/13		6/8	<b>PMESWT0100</b>	5/39
		<b>BMXDIAI1615H</b>	6/6	<b>BMXFCC503</b>	3/13	<b>BMXFTW505</b>	6/7	<b>PMXCDA0400</b>	5/41
		<b>BMXDIAI1615H</b>	6/6	<b>BMXFCC1001</b>	3/13	<b>BMXFTW505S</b>	3/23	<b>PMXETW0100</b>	5/43
		<b>BMXDIAI1615H</b>	6/6	<b>BMXFCC1003</b>	3/13		6/8	<b>PMXNOW0300</b>	5/35
		<b>BMXDIAI1615H</b>	6/6	<b>BMXFCW301</b>	3/13	<b>BMXFTW1001</b>	3/13		
		<b>BMXDIAI1615H</b>	6/6		6/7		6/7	<b>S</b>	
		<b>BMXDIAI1615H</b>	6/6	<b>BMXFCW301S</b>	3/23	<b>BMXGEL0025</b>	6/4	<b>STBXSP3010</b>	2/5
		<b>BMXDIAI1615H</b>	6/6		6/8	<b>BMXMSP0200</b>	3/37		6/4
		<b>BMXDIAI1615H</b>	6/6	<b>BMXFCW303</b>	3/13	<b>BMXNGD0100</b>	5/23	<b>STBXSP3020</b>	2/5
		<b>BMXDIAI1615H</b>	6/6		6/7	<b>BMXNOE0100H</b>	6/9		6/4
		<b>BMXDIAI1615H</b>	6/6	<b>BMXFCW501</b>	3/13	<b>BMXNOE0110H</b>	6/9	<b>T</b>	
		<b>BMXDIAI1615H</b>	6/6		6/7	<b>BMXNOM0200</b>	5/27	<b>TCSEGPA23F14FK</b>	6/10
		<b>BMXDIAI1615H</b>	6/6	<b>BMXFCW501S</b>	3/23	<b>BMXNOM0200H</b>	6/9	<b>TCSMCN3M4F3C2</b>	5/27
		<b>BMXDIAI1615H</b>	6/6		6/8	<b>BMXNOM0200H</b>	6/9	<b>TCSMCN3M4M3S2</b>	5/27
		<b>BMXDIAI1615H</b>	6/6	<b>BMXFCW503</b>	3/13	<b>BMXNOR0200H</b>	6/9		6/10
		<b>BMXDIAI1615H</b>	6/6		6/7		5/19	<b>TCSXCN3M4F3S4</b>	5/27
		<b>BMXDIAI1615H</b>	6/6	<b>BMXFCW1001</b>	3/13	<b>BMXNRP0200</b>	5/4		6/10
		<b>BMXDIAI1615H</b>	6/6		6/7	<b>BMXNRP0200C</b>	6/9	<b>TSXCBY010K</b>	2/9
		<b>BMXDIAI1615H</b>	6/6	<b>BMXFCW1003</b>	3/13	<b>BMXNRP0201</b>	5/4		6/5
		<b>BMXDIAI1615H</b>	6/6		6/7	<b>BMXNRP0201C</b>	6/9	<b>TSXCBY030K</b>	2/9
		<b>BMXDIAI1615H</b>	6/6	<b>BMXFTA150</b>	3/23	<b>BMXPRA0100</b>	5/7		6/5
		<b>BMXDIAI1615H</b>	6/6	<b>BMXFTA152</b>	3/23	<b>BMXRWS128MWF</b>	5/19	<b>TSXCBY050K</b>	2/9
		<b>BMXDIAI1615H</b>	6/6		6/8	<b>BMXRWSC016M</b>	5/23		6/5
		<b>BMXDIAI1615H</b>	6/6	<b>BMXFTA300</b>	3/23	<b>BMXSIAI0410</b>	4/9	<b>TSXCBY120K</b>	2/9
		<b>BMXDIAI1615H</b>	6/6	<b>BMXFTA302</b>	3/23	<b>BMXSDI1602</b>	4/8		6/5
		<b>BMXDIAI1615H</b>	6/6		6/8	<b>BMXSDO0802</b>	4/8	<b>TSXCBY180K</b>	2/9
		<b>BMXDIAI1615H</b>	6/6	<b>BMXFTB2000</b>	3/13	<b>BMXSRA0405</b>	4/8		6/5
		<b>BMXDIAI1615H</b>	6/6		3/23	<b>BMXXBC008K</b>	2/9	<b>TSXCBY280KT</b>	2/9
		<b>BMXDIAI1615H</b>	6/6		3/31		6/5		6/5
		<b>BMXDIAI1615H</b>	6/6		4/8	<b>BMXXBC015K</b>	2/9	<b>TSXCBY1000</b>	2/9
		<b>BMXDIAI1615H</b>	6/6		4/9		6/5		6/5
		<b>BMXDIAI1615H</b>	6/6		6/6	<b>BMXXBC030K</b>	2/9	<b>TSXCBYACC10</b>	2/9
		<b>BMXDIAI1615H</b>	6/6		6/8		6/5		6/5
		<b>BMXDIAI1615H</b>	6/6		6/11	<b>BMXXBC050K</b>	2/9	<b>TSXCBYK9</b>	2/9
		<b>BMXDIAI1615H</b>	6/6	<b>BMXFTB2010</b>	3/13		6/5		6/5
		<b>BMXDIAI1615H</b>	6/6		3/23	<b>BMXXBC120K</b>	2/9	<b>TSXCBYK9</b>	2/9
		<b>BMXDIAI1615H</b>	6/6		3/31		6/5		6/5
		<b>BMXDIAI1615H</b>	6/6		4/8		6/5	<b>TSXTLYEX</b>	2/9
		<b>BMXDIAI1615H</b>	6/6		4/9		6/5		6/5
		<b>BMXDIAI1615H</b>	6/6		6/6	<b>BMXXBE1000</b>	2/9	<b>V</b>	
		<b>BMXDIAI1615H</b>	6/6		6/8	<b>BMXXBE1000H</b>	6/4	<b>VW3M8223R30</b>	3/37
		<b>BMXDIAI1615H</b>	6/6		6/11	<b>BMXXBE2005</b>	2/9		
		<b>BMXDIAI1615H</b>	6/6	<b>BMXFTB2020</b>	3/13	<b>BMXXBP0400</b>	2/4		
		<b>BMXDIAI1615H</b>	6/6		3/23	<b>BMXXBP0400H</b>	6/4		
		<b>BMXDIAI1615H</b>	6/6		3/31	<b>BMXXBP0600</b>	2/4		
		<b>BMXDIAI1615H</b>	6/6		4/8	<b>BMXXBP0600H</b>	6/4		
		<b>BMXDIAI1615H</b>	6/6		4/9	<b>BMXXBP0800</b>	2/4		
		<b>BMXDIAI1615H</b>	6/6		6/6	<b>BMXXBP0800H</b>	6/4		
		<b>BMXDIAI1615H</b>	6/6		6/8		6/4		
		<b>BMXDIAI1615H</b>	6/6		6/11		6/4		
		<b>BMXDIAI1615H</b>	6/6		6/11		6/4		

Life Is On



Learn more about our products at  
[www.schneider-electric.com](http://www.schneider-electric.com)

The information provided in this documentation contains general descriptions and/or technical characteristics of the performance of the products contained herein. This documentation is not intended as a substitute for and is not to be used for determining suitability or reliability of these products for specific user applications. It is the duty of any such user or integrator to perform the appropriate and complete risk analysis, evaluation and testing of the products with respect to the relevant specific application or use thereof. Neither Schneider Electric nor any of its affiliates or subsidiaries shall be responsible or liable for misuse of the information contained herein.

Design: Schneider Electric  
Photos: Schneider Electric

**Schneider Electric Industries SAS**

Head Office  
35, rue Joseph Monier - CS 30323  
F-92500 Rueil-Malmaison Cedex  
France

DIA6ED2131203EN  
January 2020 - V11.0